

MINIPUMP MP-ΣNI Series

OPERATION MANUAL





Thank you for purchasing this product.

- This operation manual describes precautions that are important for preventing accidents as well as the procedures used to handle the product.
- To ensure safety, read this operation manual and the attached warranty thoroughly before use, and use the product correctly.
- After reading this operation manual and the warranty, keep them in a safe place where they can be referred to at any time.

Contents

Before Use	1
Safety Precautions	2
Product Overview	5
Features.....	5
Names of Parts	6
How to Install the Battery	8
How to Remove the Battery	9
Wiring Methods	10
Charging Methods	11
Installation and Piping Methods	12
How to Install the Suction Holder.....	14
Preparing for Operation	15
Operation Modes	16
Manual Mode	17
Down Timer Mode	18
Volume Timer Mode.....	20
Cycle Timer Mode	22
Numeric Value OVER Display	25
After Ending Operation	26
Memory.....	27
Extra Menu	28
Submenus.....	31
Errors	34
Troubleshooting.....	34
Main Specifications	36
LCD Screen Indications and Meanings.....	38
Options (Including Consumables)	39
Maintenance	39
Warranty and Repair.....	39
Disposal of the Product	40
Inquiries.....	40
Trouble Notification Sheet.....	41

Before Use

 WARNING	<ul style="list-style-type: none"> ● This product does not have an explosive-proof structure. Do not use this product in hazardous location to prevent an explosion accident. ● Be sure to read this operation manual thoroughly before using the product, and be sure to use the product correctly. ● Keep this operation manual in a safe place where it can be referred to at any time. ● Be sure to familiarize yourself with, and observe, the safety precautions given in this operation manual. ● Observe usage procedures that are suitable for the product and that are specified in this operation manual. <p>Be sure to observe the above instructions. Not following these instructions may result in an accident or injury.</p>
 CAUTION	<ul style="list-style-type: none"> ● Do not allow water and other liquids, and gases other than air to be sucked in. Doing so might cause malfunction. ● Do not allow flammable gases to be sucked into this product. Doing so might cause malfunction or fire. ● Do not allow corrosive gases, organic solvent, chemicals or salt spray to be sucked in. Doing so might cause malfunction.

■ About This Operation manual

- In the interests of product improvement, the contents of this operation manual may be changed without notice.
- Every effort has been made to ensure that the information contained in this operation manual is correct. If you discover any errors or omissions, however, please contact your Sibata representative.
- The copyright of this operation manual belongs to Sibata Scientific Technology Ltd.
The reproduction of all or part of this operation manual without prior written permission from Sibata Scientific Technology Ltd. is prohibited.

■ Checking the Package

Check the contents of the package before using the product.

- MP-ΣN II Series Unit 1
- Suction Holder for Ultra Low Flow Rate (MP-Σ30N II only) 1
- MANUFACTURER'S INSPECTION RESULT 1
- Operation manual (this document) 1

Safety Precautions

The precautionary information that appears in this operation manual is for ensuring that the product is used safely and for preventing injury to you and other people and damage to equipment. It is all important for ensuring safety and so be sure to read it thoroughly before using the product and observe it during use.

■ About the User (Important)

This product must be operated only by persons with adequate specialist skills, training, and experience to understand the potential dangers of operating the product.



Personnel who are untrained or still undergoing training may operate the product only under guidance from a trained person or a person with specialized experience.

This operation manual was written on the assumption that the product will be operated only by users who fully understand the potential dangers of operating the product.

■ Warning Labels

In this operation manual, precautionary information is labeled. The degree of damage or injury that may occur if the product is used without consideration of the corresponding item of precautionary information is indicated by one of three labels: **DANGER**, **WARNING** and **CAUTION**. These labels indicate precautionary information that is important for ensuring safety and so be sure to observe them.

Labels Indicating Degrees of Damage or Injury

 DANGER	Indicates a potentially hazardous situation which, if not avoided, could result in serious injury or possibly death.
 WARNING	Indicates a potentially hazardous situation which, if not avoided, could result in serious injury.
 CAUTION	Indicates a potentially hazardous situation which, if not avoided, may result in minor to moderate injury or equipment damage.



- Use only the exclusive batteries (LI-10N Battery Unit, DB-10N Dry Battery Unit) on the body of this product (Mini Pump MP-ΣN II Series). Do not use other batteries. Doing so might damage this product or harm the human body.
- Connect to only the specified power adapter (QC-10N, PA-1203). Do not connect to other adapters.
- Do not use this product near highly flammable or potential fire hazards, or allow gases other than air to be sucked in. Doing so might cause explosion or fire.
- No Fires Allowed! Do not put this product into fires. Doing so might cause explosion or fire.
- Do not connect the connector electrodes with wire or other metal objects. Doing so might cause burns, battery leakage, generation of heat, or explosion.
- Charge the LI-10N using only the exclusive charger (QC-10N). Charging the battery by other methods might cause battery leakage, generation of heat or explosion.

WARNING

- Do not allow this product to be directly splashed with water. Doing so might cause electric shock or fire.
- Do not subject this product to strong impact or drop it. Doing so might cause malfunction or accidents.
- Do not leave this product inside cars in the hot sun, or install or store it in strong direct sunlight, in front of heating equipment or next to fires. Doing so might cause abnormal operation or malfunction.
- Never connect by methods other than those described in this manual, for example, by connecting to connectors using wire or other metal. Doing so might cause fire or damage the hardware.
- Never dismantle or modify this product. Doing so might cause malfunction or accidents.
- If an abnormality occurs during operation, immediately stop operation and remove the cause of the abnormality. When the abnormality is judged to be caused by this product, remove the battery and contact your Sibata agent. Do not use this product in an abnormal state or allow it to be dismantled for repair by non-service personnel. Doing so might cause malfunction or accidents.
- Do not run this product wrapped in a cloth or bedding, or enclosed in a box. Doing so might cause heat to build up, resulting in fire or malfunction.
- Do not connect the power adapter to a multi-plug power strip. Doing so might cause electric shock or fire. Before using this product on a non-specified voltage, contact your Sibata agent.
- Do not use this product when the power cable is damaged or the plug inlet on the power outlet is loose. Use in this state might cause fire or electric shock.
- Do not touch the power cable or power outlet with wet hands. Doing so might cause electric shock.
- The service life of the LI-10N is limited. Replace with a new LI-10N when battery use becomes increasingly shorter after each recharge. If this product is used beyond the LI-10N's replacement cycle, the battery might become damaged which will cause battery leakage.
- This product is made for indoor use. Do not use it in environments that may be exposed to wind and rain. Doing so might cause malfunction.
- Do not block the exhaust port. Doing so will prevent the required airflow into the product, and cause heat to build up inside, resulting in malfunction or fire.

CAUTION

● **Avoid sampling asbestos using the MP-Σ500N II.**

In the context of air quality measurements for asbestos, which has become a social issue, one of the methods used is to **collect samples for 2 hours at 5 L/min.** (As per the JATI guidelines for indoor air)

Because of the special characteristics of the filter used in this measurement method, a significant load is placed on the pump, so a pump that provides sufficient suction pressure (10 kPa or higher) must be used.

The suction flowrate range for the MP-Σ500N II is 2 L/min to 5 L/min, and at 5 L/min, the suction pressure will be 0 kPa to 3.0 kPa, which means that **the specifications range will be exceeded if the MP-Σ500N II is used to collect samples for 2 hours at 5 L/min.**

It cannot likely be used correctly under these conditions, either due to a loss of suction or a tendency to malfunction. Accordingly, if you are making measurements under these conditions, use the AIP-105/AIP-205 Asbestos Sampling Pump. Note that if a problem occurs when the MP-Σ500N II is used under these conditions, it will not be covered under the one-year warranty.

CAUTION

- Install this product on a horizontal, stable site. Installation on an unstable location might cause abnormal operation or malfunction.
- When not using this product for a long time, remove the battery, disconnect the power adapter, and store in as cool and dry a location as possible out of the direct sunlight.
- Do not place objects on top of this product. Doing so might cause the product to tip over or deform the product, resulting in accident or malfunction.
- Take care not to nip your fingers when assembling the product, for example, when installing the battery.
- Do not wash this product with water. Doing so might cause electric shock, fire or malfunction.
- This product is exclusively for sampling air. Do not use it for purposes other than those described in this manual. Doing so might cause malfunction.
- Do not allow water and other liquids, and gases other than air to be sucked in. Doing so might cause malfunction.
- Be sure to run this product with a filter element attached to the suction holder. Also, run it with the dust collector attached to the suction port. If this product is allowed to suck in air directly (i.e. without filtering) for a long period of time, it might malfunction.
- Do not allow flammable gases to be sucked into this product. Doing so might cause malfunction or fire. Also, do not allow corrosive gases (e.g. salt spray) or chemicals to be sucked in. Doing so might cause malfunction.
- Do not insert screws or other foreign objects into the suction and exhaust ports. Doing so might cause malfunction. Should foreign objects get inside this product, immediately turn the power switch OFF, disconnect the power plug, and contact your Sibata agent.
- When disconnecting the power plug, be sure to hold the power cable by the power plug. Pulling the cable might damage it and cause electric shock or fire.
- Do not place heavy objects or step on the power cable. Doing so might cause electric shock or fire.
- The operating temperature and humidity ranges of this product are 0 to 40°C and 10 to 90% rh (no condensation), respectively. Use of this product outside of these ranges might impair its performance and service life, resulting in malfunction.
- Even when not using the LI-10N for a long time, charge it at least once every six months to prevent over discharging of its lithium cell. This prevents the LI-10N from deterioration.
- Before use, check the sheath of the power adapter cable for scratches or other abnormalities. Use in an abnormal state might cause fire or electric shock.
- Before cleaning or inspecting this product, remove the battery and the power adapter. Failure to do so might cause electric shock, electric leak or other abnormalities.
- Do not bring this product close to equipment that generates electrical noise. Also, do not install it at locations subject to strong magnetic fields, or lots of dust or humidity. Doing so might damage the hardware, for example.
- Note that, should some nonconformity occur, SIBATA does not assume any liability whatsoever for compensation of data or content that could not be acquired or logged as a result, loss of data or other content, and other direct and indirect damages relating to the preceding. Periodically back up data as a precaution against malfunction or accidents.

Product Overview

The Mini Pump MP-ΣN II Series is an ultra-lightweight, portable pump designed exclusively for sampling air, and features integrated flow measurement functions. Three models are available each with different flow volume ranges: the MP-Σ30N II with a maximum flow rate of 0.5 L/min, the MP-Σ300N II with a maximum flow rate of 3 L/min, and the MP-Σ500N II with a maximum flow rate of 5 L/min, Total 4 models available including MP-Σ100HN II with a maximum flow rate of 1.5L/min. The pump has a built-in mass-flow sensor, and the instantaneous flow rate and integrated flow volume measurement values are displayed digitally.

It also has a constant flow flow rate function to minimize drops in the suction flow volume accompanying increased suction pressure caused by sampling of dust, etc. It has a high suction pressure and constant suction flow rate, which means that it can be used in a wide range of applications as a pump for sampling air-borne harmful substances in work and indoor environments.

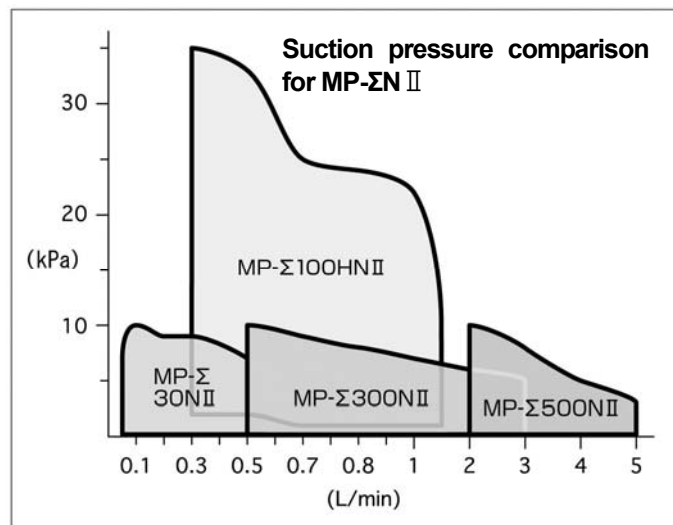

Features

- Has a built-in mass-flow sensor for directly measuring suction flow rate and displaying instantaneous and integrated flow volumes as digital values.
- Incorporates a constant flow rate function to minimize drops in the suction flow rate accompanying increased suction pressure caused by sampling of dust, etc.
- Has four timer sampling modes (manual, down timer, volume timer, cycle timer*).
- The liquid crystal display incorporates backlighting so that displayed flow rate and other values can be checked even in dark locations.
- The state of the filter element can be visually checked.
- Incorporates a measurement data log function so that the last ten measurement results can be checked on the pump. The number of logged measurement results can be increased to up to 99 by using communications software (sold separately) for uploading to a PC.
- Three power sources are supported:
 - Lithium-ion rechargeable cell (LI-10N Battery Unit) [sold separately]
 - Dry cell 8 × AA batteries (DB-10N Dry Battery Unit) [sold separately]
 - AC power source (QC-10N Quick Charger) [sold separately]
 - (PA-1203 AC adapter) [sold separately]
- The MP-ΣN II series widens its constant flow rate range and lengthens its battery operating time relatively to the MP-ΣN series. (Refer details on "Main Specifications".)

* To use the cycle timer mode, communications software (sold separately) and a PC are required.

Names of Parts

MP-ΣN II + LI-10N (or DB-10N)



- (1) Battery Unit (LI-10N or DB-10N)
- (2) Model nameplate
- (3) Suction port (suction holder)
- (4) Power switch
- (5) Exhaust port
- (6) Rubber cover
- (7) Operation panel

- (8) Charging connector (LI-10N only)
- (9) Hook
- (10) Slide lock
- (11) Tripod mounting hole (base)
- (12) Power source connector
- (13) USB (Mini-B) connector
- (14) Filter check window

Operation Panel



- | | |
|---------------------------|--------------------|
| (1) Operation display LED | (5) START/STOP key |
| (2) MODE key | (6) KEY LOCK key |
| (3) UP key | (7) LCD screen |
| (4) DOWN key | |

The meanings of the operation display LED indications are as follows: flashing (green) - pump operating, flashing (red) - error occurred and pump operation stopped, and flashing (orange) - timer standing by or connecting to PC.

LCD Screen

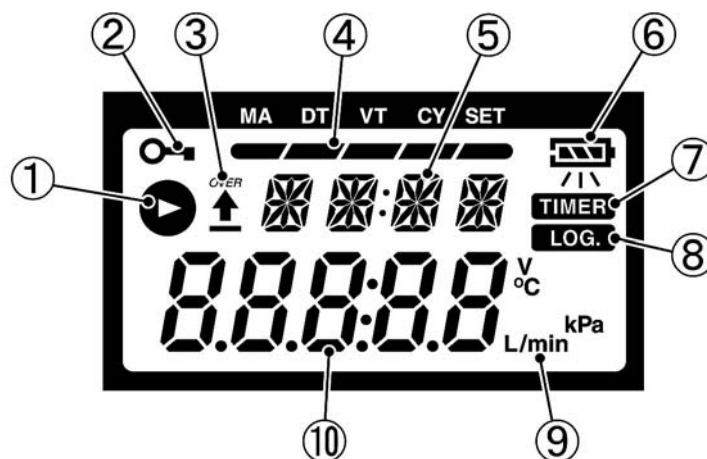

- | | |
|-----------------------------|----------------------------|
| (1) Pump operation mark | (6) Battery status |
| (2) Key lock | (7) Timer standing by |
| (3) Flow volume exceeded | (8) Log check mode |
| (4) Mode display bar | (9) Unit |
| (5) Character display field | (10) Numeric display field |

How to Install the Battery

Fit the battery into the body while referring to the mounting position mark on the body.

* **Take care not to touch the electrodes.**

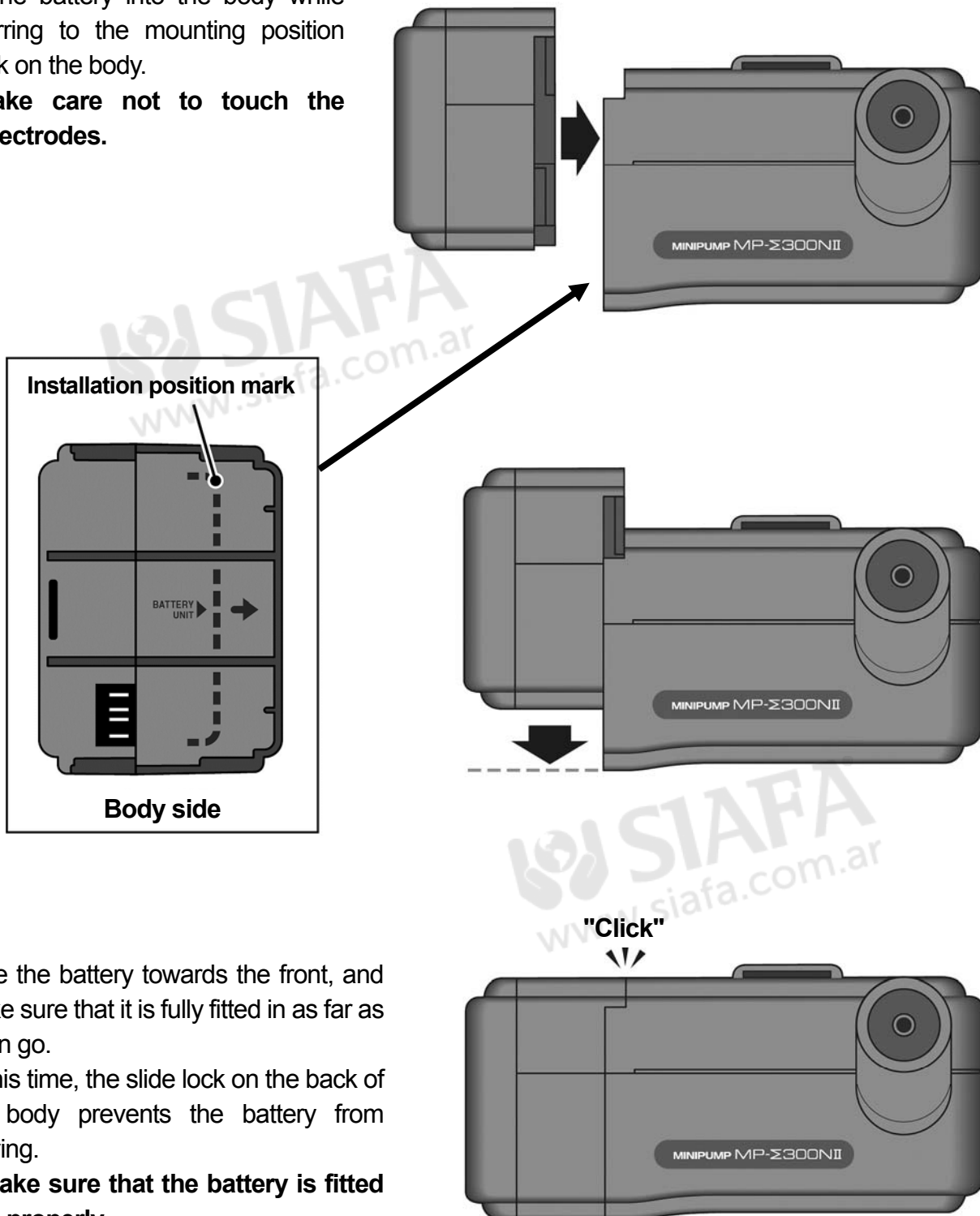

Slide the battery towards the front, and make sure that it is fully fitted in as far as it can go.

At this time, the slide lock on the back of the body prevents the battery from moving.

* **Make sure that the battery is fitted in properly.**

How to Remove the Battery

Before removing the battery, slide the slide lock on the back of the body as shown in the figure to unlock the lock.

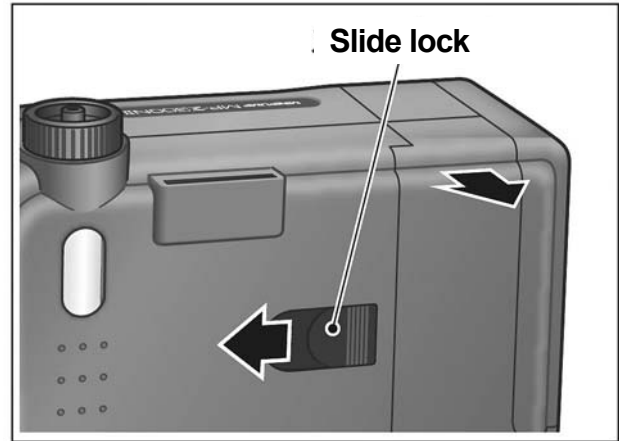

With the slide lock unlocked, slide the battery towards the rear to the stop position as shown in the figure.

⚠ CAUTION

Do not slide using excessive force. The battery will come loose; but, the electrodes on the body might become damaged.

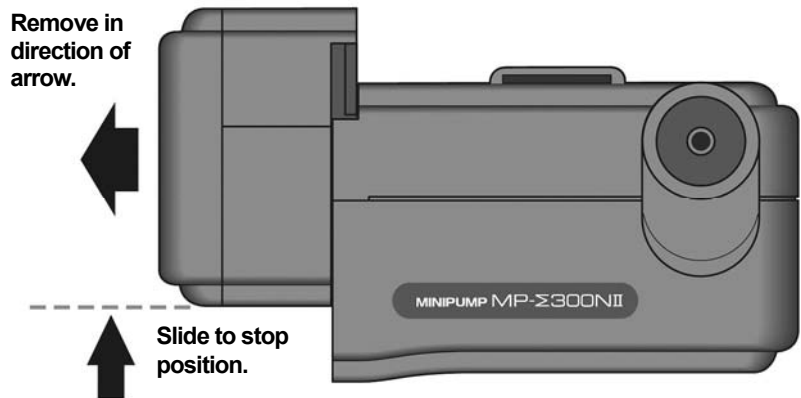

The battery can be removed towards the left when it is at the stop position.

Wiring Methods

When Used with the AC Power Source

The pump can be operated by an AC power source by connecting the QC-10N Quick Charger (sold separately) directly to the pump body. Also, the pump can be operated and the LI-10N (sold separately) charged at the same time with the LI-10N installed.

Even if the AC adapter PA-1203 (sold separately) is connected to the pump body, the body can be operated; however, the LI-10N cannot be charged.

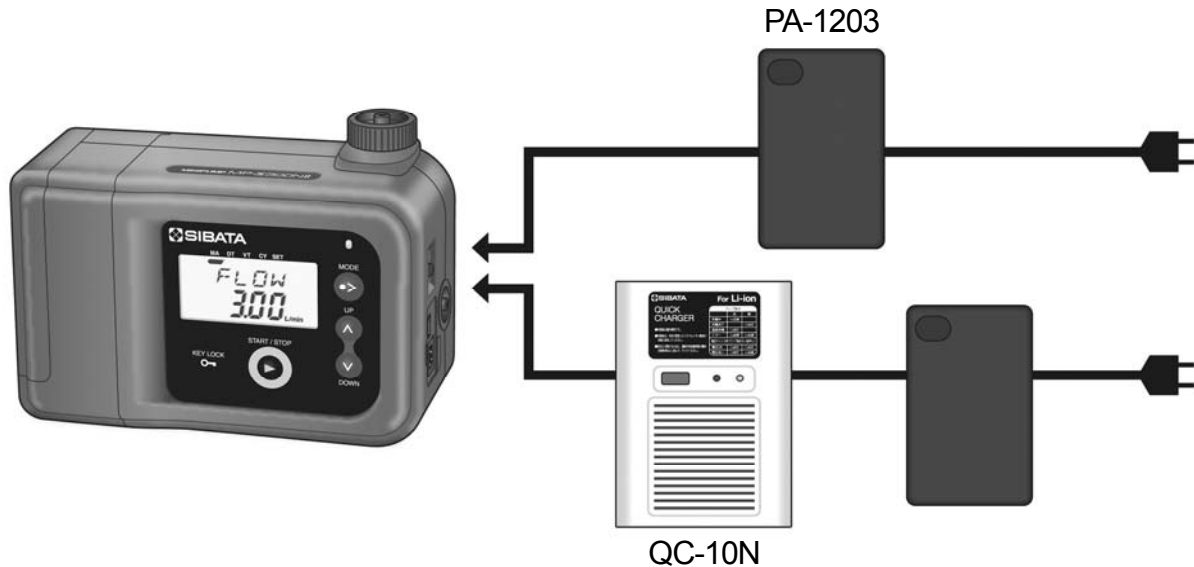

When Using the Battery

The pump can be used by installing the LI-10N or DB-10N.

The battery status mark is displayed on the screen when the power is turned ON with the battery installed. (It is not displayed when the AC power source is connected.)

Battery status	
	70% or more power
	30% or more power
	Less than 30%
	0% The pump stops operating. The battery must be recharged or replaced immediately.

- * When a battery other than an alkaline battery is used on the DB-10N, the battery status icon will not function properly.
- * Do not remove the battery during pump operation.
- * The battery can be replaced with the DB-10N installed on the pump body. However, before replacing the battery, be sure to turn the pump OFF.

If the pump is operated from the AC power source with the battery inside, the power source will automatically switch to the battery in the event of a power interruption, and measurement can be continued in this state.

In cases such as this, measurement can be performed more safely by using the Quick Charger QC-10N as the AC power source and the Battery Unit LI-10N as the battery since the battery is automatically charged after AC power is restored.

Charging Methods

The LI-10N Battery Unit (sold separately) is charged using the QC-10N Quick Charger (sold separately). As shown in the figure, the LI-10N can be charged by connecting the QC-10N to the pump body with the LI-10N installed.



Also, the LI-10N has a charging connector. So, the battery itself can be charged by connecting the LI-10N directly to the QC-10N.

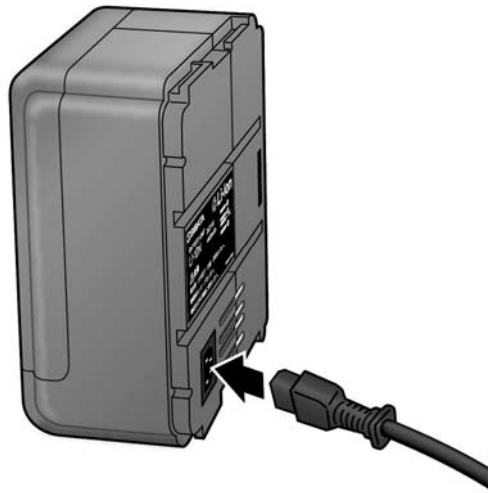

While the LI-10N is being charged, the red LED on the QC-10N will flash. When charging is completed, this is indicated by lighting the green LED. Charging time is about 6 hours. For details, refer to the QC-10N Operation Manual.

- * Be sure to use the exclusive QC-10N Quick Charger for charging the LI-10N Battery Unit. Use of other chargers might cause malfunction or abnormal overheating, resulting in ignition or explosion.
- * The PA-1203 uses the same connector as that on the QC-10N. However, do not connect this to the LI-10N. The LI-10N cannot be charged even if the PA-1203 is connected.

Installation and Piping Methods

Install the pump body on a flat location. When choosing an installation site, avoid humid locations or locations that are splashed with water, locations near fire or heat generating sources, and extremely dust locations.

The pump body can also be mounted on a tripod. Insert the tripod screws into the tripod mounting hole on the base of the pump body. If a tripod with a mounting base over 40 mm is used (i.e. one that will result in a mounting footprint of 20 mm or more wide from the tripod screw at its center), the pump body sometimes cannot be installed stably.

Make sure that the filter element is attached to the suction holder. Also, replace the filter element when it becomes particularly dirty. (See page 14 "How to Install the Suction Holder.")

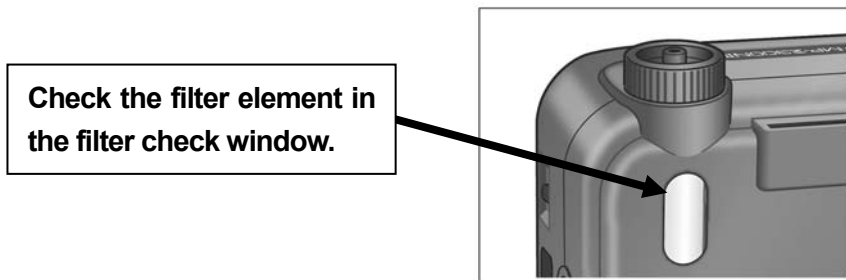

5 mm dia. and 7 mm dia. tube can be inserted onto the suction port.

* When inserting piping, take care to prevent strong force from being applied to the suction holder. Unnecessary force will damage the suction port.

Likewise, 5 mm dia. and 7 mm dia. tube can be inserted onto the exhaust port. However, pay attention to the following points:

- The piping itself sometimes acts as a load and prevents suction performance as indicated in the specifications from being achieved.
- The flow volume on the exhaust side cannot be controlled. Treat indicated flow volume values for reference only.

During Ultra Low Flow Volume Measurement (supported only on MP-Σ30N II)

When measuring under a flow rate of 0.150 L/min or less, use the ultra low flow rate suction holder that is provided.

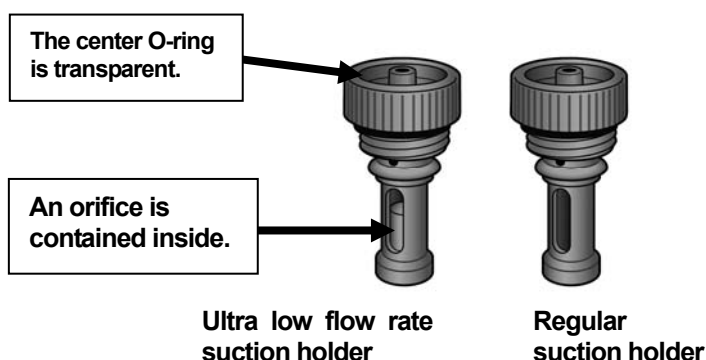

Suction Pressure

A load (suction pressure) is applied to the pump by collected matter in the dust collector installed on the suction port.

On each of the pump models, the maximum suction pressure is determined by respective flow rate. (See page 36 "Main Specifications.") Exceeding the specification range will cause malfunction; however, this pump does not have a function for measuring suction pressure. So, we recommend measuring the suction pressure of collected matter in advance referring to the diagram below.

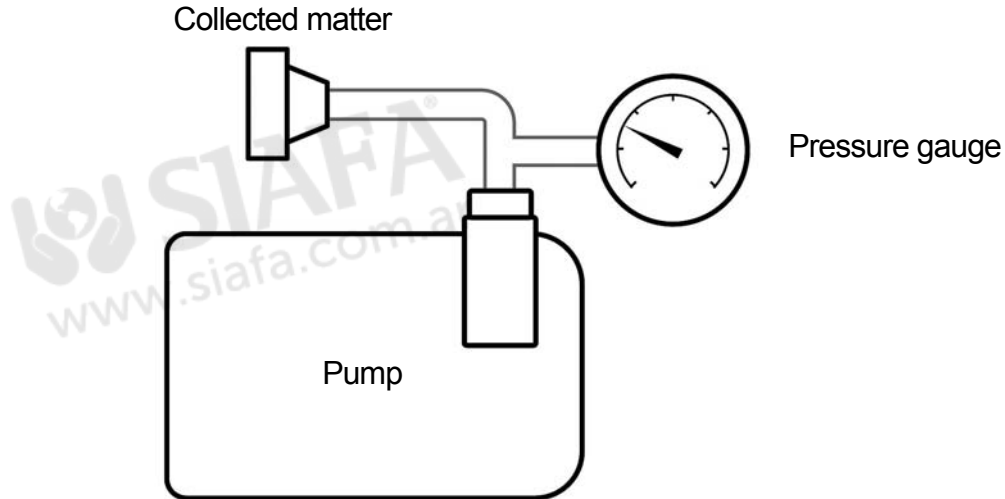

When Using an Impinger

In use of mini pumps that use an impinger, liquid will be sucked into the pump body if the piping is connected in the wrong way, which will result in malfunction. Install piping referring to the following diagram.

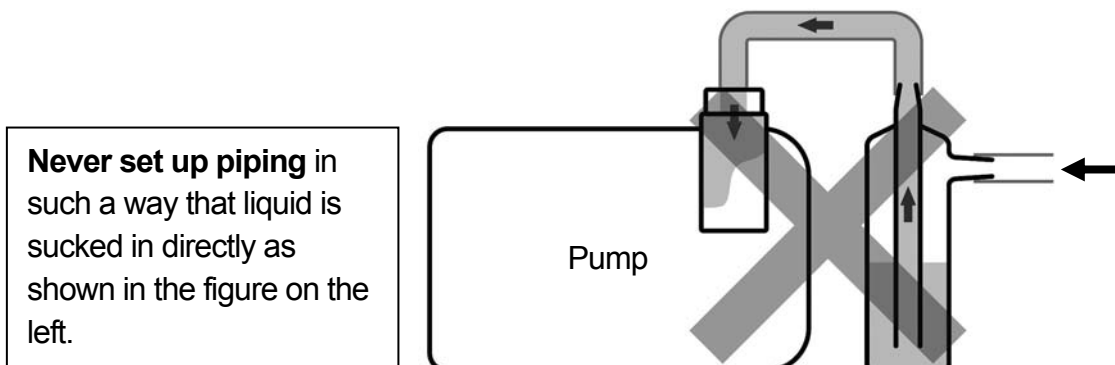
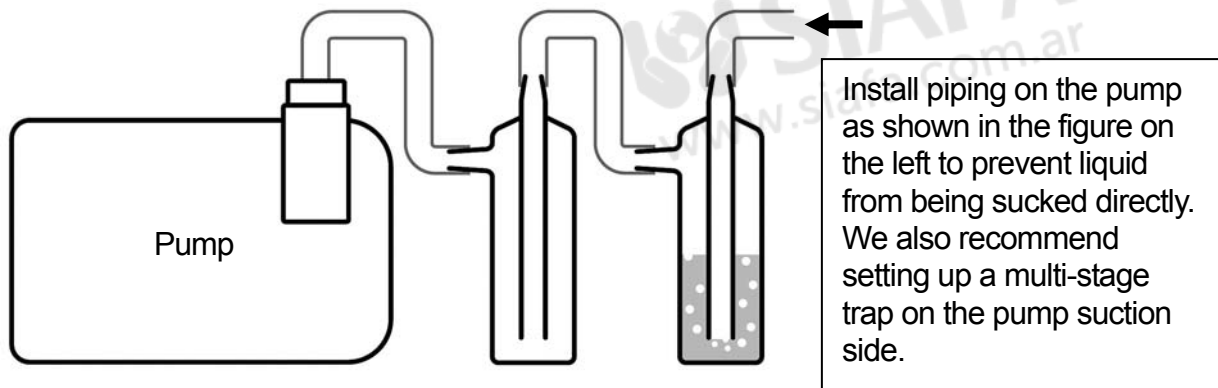

How to Install the Suction Holder

The suction holder can be removed from the suction port by turning it counterclockwise.

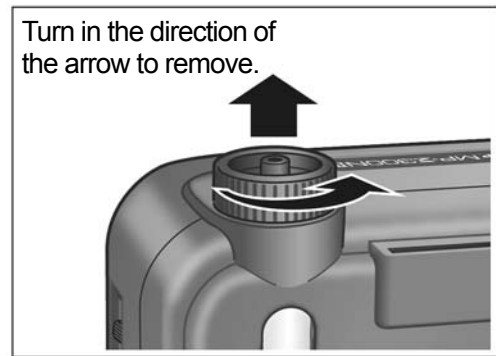

The filter element in the suction holder can be replaced by pulling lightly.

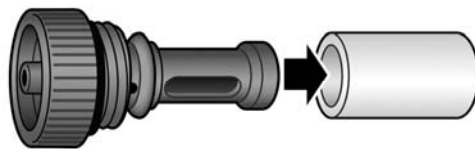

Be sure to insert the filter element into the suction holder before installing the suction holder. Turn the suction holder clockwise to install.

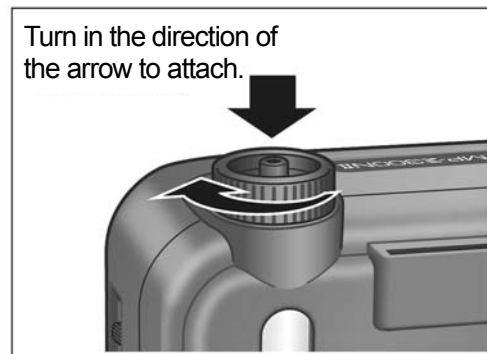
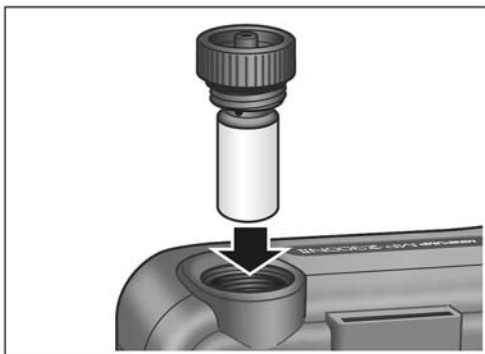

* Turn the suction holder in as far as it will go. It may cause air leakage if the holder is not turned in firmly. However, do not overtighten the suction holder. Doing so might prevent it from being removed again or cause malfunction. Tightening the suction holder hard does not necessarily result in improved air tightness.

Preparing for Operation

Make sure that the wiring and piping have been properly connected.

Turn ON the power switch on the side of the pump body.

The version and flow rate conversion temperature value are displayed on screen, and the screen changes as follows.



- * When using the pump for the first time, the manual mode screen will be displayed. Normally, the screen for the mode used in the previous measurement is displayed.
- * The battery status mark is not displayed when the pump is operated from the AC power source.

Each press of the MODE key switches the screen cyclically as follows: manual mode → down timer mode → volume timer mode → cycle timer mode → memory → extra menu.

Each press of the MODE key switches the segment to light on the mode display bar at the top of the LCD screen to indicate the current mode.

MA: manual mode

DT: down timer mode

VT: volume timer mode

CY: cycle timer mode

SET: setup in progress (Not displayed using only the MODE key.)

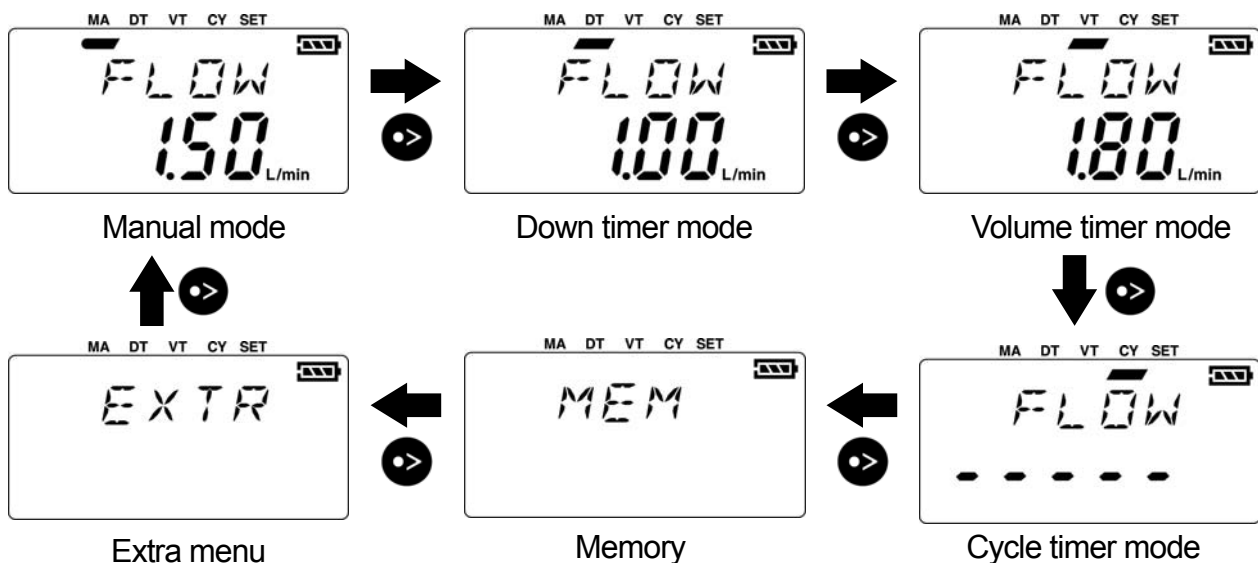

The mode display bar is not lit in the memory and extra menu screens.

Operation Modes

This pump has the following four operation modes.

(1) Manual mode operation (See page 17.)

Pressing the START/STOP key starts and stops pump operation.
The only setup item provided is instantaneous flow rate.

(2) Down timer mode operation (See page 18.)

Pressing the START/STOP key operates the pump for the preset time.
Three setup items are provided in this mode: instantaneous flow rate, sampling start time and sampling time (end time).

(3) Volume timer mode operation (See page 20.)

Pressing the START/STOP key starts pump operation at the preset time. Pump operation ends when the preset integrated flow volume value is reached.
Three setup items are provided in this mode: instantaneous flow rate, sampling start time and sampling end integrated flow volume.

(4) Cycle timer mode operation (See page 22.)

To use this mode, communications software (sold separately) and a PC are required.
In this mode, the pump can be operated automatically in accordance with the setup details preset on the PC. Setups for up to five measurements can be registered in advance.
For details, refer to the communications software operation manual.

In the explanations for each of the following modes, it states that the operation display LED flashes. However, the LED can also be set up not to flash. (See page 29.)

Manual Mode

LED display conventions



Press the MODE key until the MA segment of the mode display bar lights. The instantaneous flow rate setting is displayed initially in this screen. The integrated flow volume and other setup items are sometimes displayed by using the UP/DOWN key. (See page 26 "After Ending Operation.")

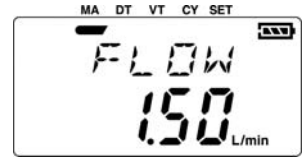

In the manual mode, only the flow volume is set.

Holding down the MODE key in this screen causes the SET segment of the mode display bar to light and the flow rate value to flash. In this state, the flow volume can be set.

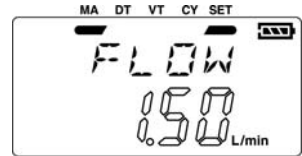

Change the numeric value by pressing the UP/DOWN key to set the flow rate.

After setting the flow rate, press the START/STOP key. The flow rate value lights and the SET segment of the mode display bar goes out to indicate that setup is complete.

Pressing the START/STOP key again starts pump operation. During pump operation, the operation display LED flashes (green), the pump operation mark lights, and the instantaneous flow rate is displayed.

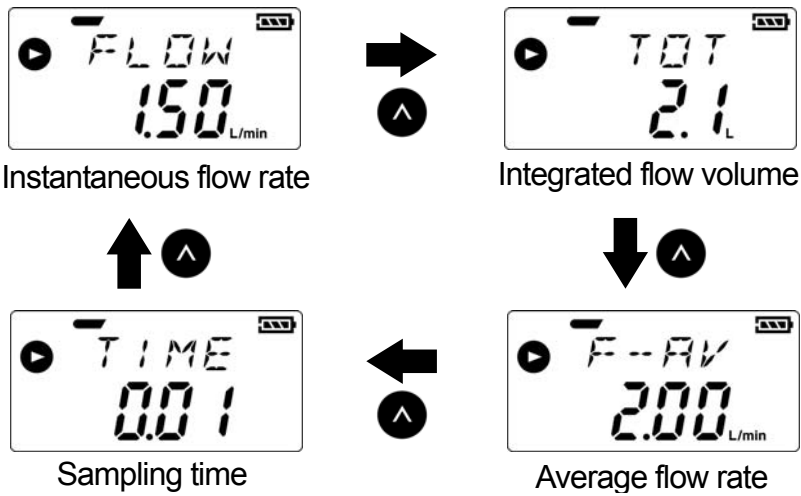

Pressing the UP key during pump operation switches the screen cyclically as follows: integrated flow volume → average flow rate → sampling time → instantaneous flow rate. Pressing the DOWN key switches the screen in the reverse direction.

Holding down the KEY LOCK key during pump operation displays the key icon as in the figure on the right and disables use of the START/STOP key.



* The above items can be checked by using the UP/DOWN key. To cancel the key lock, hold down the KEY LOCK key again. The key icon goes out and the key lock is canceled.

When the START/STOP key is pressed, pump operation stops, and the integrated flow volume screen is displayed.

* If an error occurs, the error No. is displayed and the operation display LED flashes (red). For details, see page 26 "After Ending Operation."

Down Timer Mode

LED display conventions



Press the MODE key until the DT segment of the mode display bar lights. The flow volume setting is displayed initially in this screen.

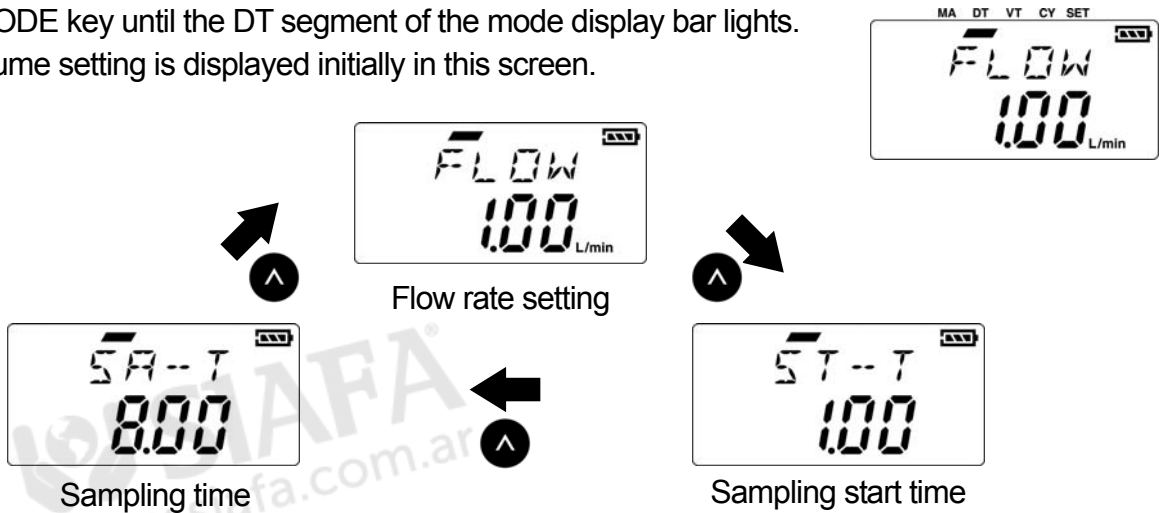

Pressing the UP key switches the screen cyclically as follows: sampling start time → sampling time → instantaneous flow rate setting. Pressing the DOWN key switches the screen in the reverse direction. The integrated flow volume and other setup items are sometimes displayed by using the UP/DOWN key. (See page 26 "After Ending Operation.")

Pressing the MODE key in any of the screens changes the mode to the volume timer mode.

In the down timer mode, only three items are set: instantaneous flow rate, sampling start time, and sampling time.

Hold down the MODE key at any of the flow rate setting, sampling start time or sampling time setup items. The SET segment of the mode display bar lights, and the display value flashes to indicate that the value can be set.



Change the numeric value by pressing the UP/DOWN key to set the flow rate.

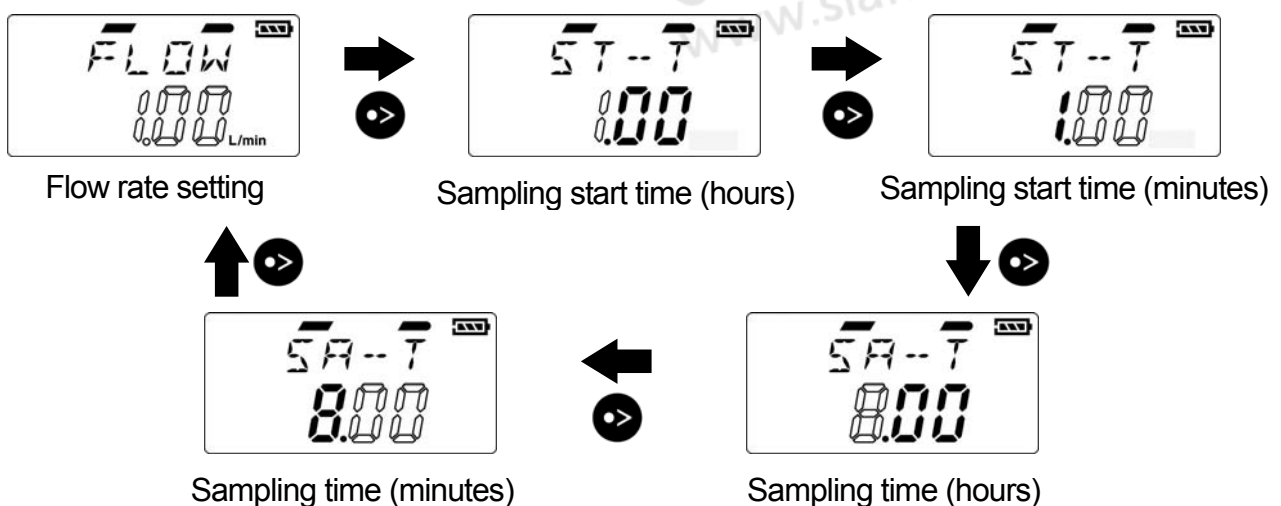

Each press of the MODE key in the setup screen switches the screen cyclically as follows: flow rate setting → sampling start time (hours) → sampling start time (minutes) → sampling time (hours) → sampling time (minutes) → flow rate setting.

After entering each of the settings, press the START/STOP key. The display value lights, and the SET segment of the mode display bar goes out to indicate that setup is complete.

Pressing the START/STOP key again starts pump operation in the down timer mode.

The operation display LED flashes (orange), the "timer standing by" icon is displayed on screen, and the remaining sampling start time is displayed.

* If the START/STOP key is pressed when the start time is set to "0.00", pump operation starts immediately.



Pressing the UP key switches the screen cyclically as follows: flow rate setting → sampling time → remaining sampling start time. Pressing the DOWN key switches the screen in the reverse direction.

Pump operation starts when the remaining sampling start time reaches "0.00".

During pump operation, the operation display LED flashes (green), the pump operation mark lights, and the instantaneous flow rate is displayed.

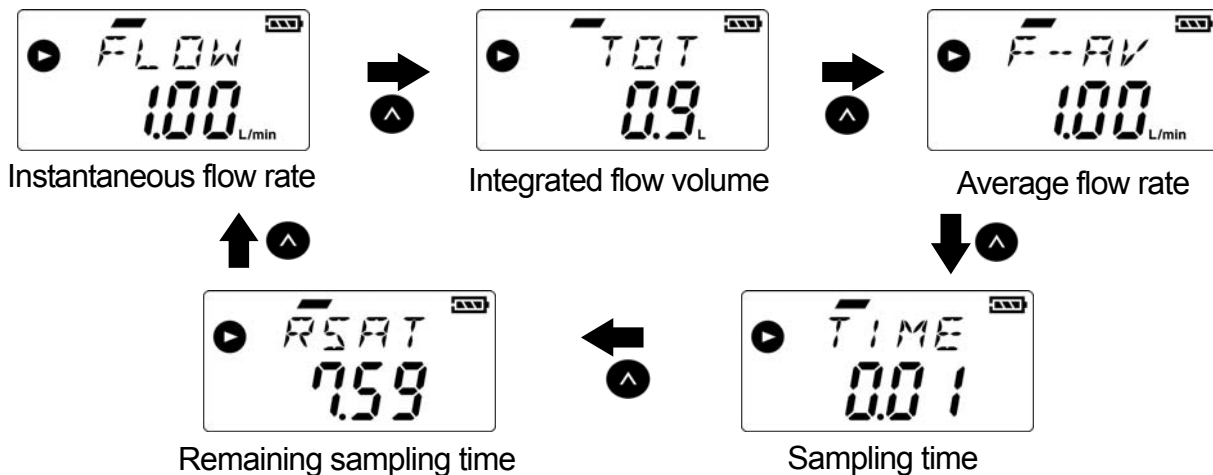

Pressing the UP key during pump operation switches the screen cyclically as follows: integrated flow volume → average flow rate → sampling time → remaining sampling time → instantaneous flow rate. Pressing the DOWN key switches the screen in the reverse direction.

Holding down the KEY LOCK key during pump operation displays the key icon and disables use of the START/STOP key.

* The above items can be checked by using the UP/DOWN key.

To cancel the key lock, hold down the KEY LOCK key again. The key icon goes out and the key lock is canceled.

When the preset sampling time is reached, pump operation stops and the integrated flow volume screen is displayed.

For details, see page 26 "After Ending Operation."

* Pump operation can be forcibly stopped by pressing the START/STOP key.

Volume Timer Mode

LED display conventions



Press the MODE key until the VT segment of the mode display bar lights. The instantaneous flow rate setting is displayed initially in this screen.

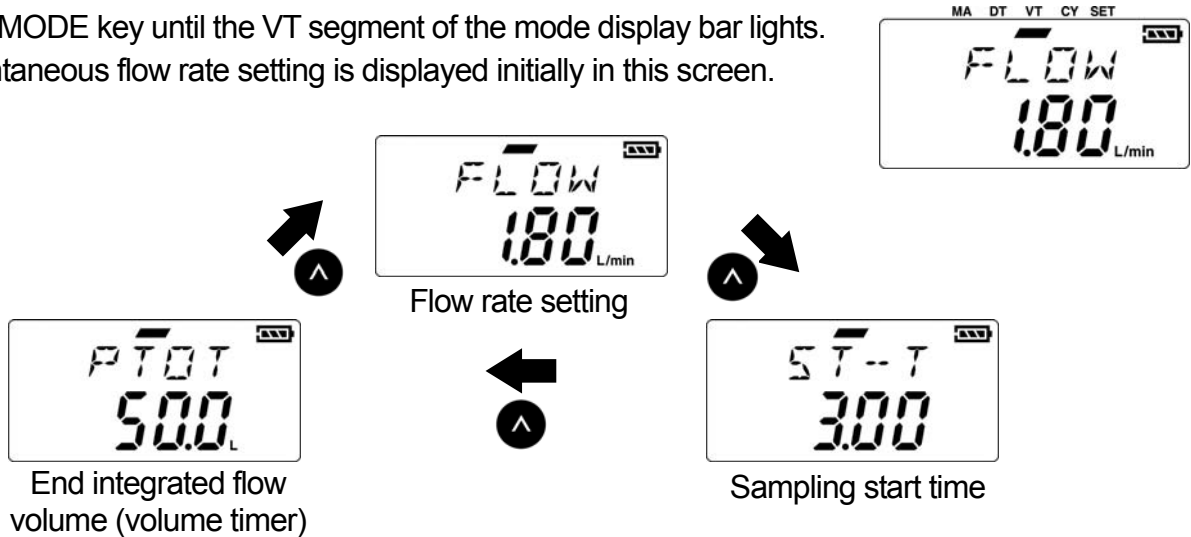

Pressing the UP key switches the screen cyclically as follows: sampling start time → volume timer → flow rate setting. Pressing the DOWN key switches the screen in the reverse direction. The integrated flow volume and other setup items are sometimes displayed by using the UP/DOWN key. (See page 26 "After Ending Operation.") Pressing the MODE key in any of the screens changes the mode to the cycle timer mode.

In the volume timer mode, only three items are set: flow rate, sampling start time, and end integrated flow volume (volume timer).

Hold down the MODE key at any of the flow rate setting, sampling start time or volume timer setup items. The SET segment of the mode display bar lights, and the display value flashes to indicate that the value can be set.

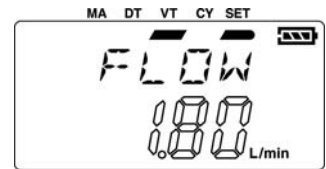

Change the numeric value by pressing the UP/DOWN key to set the flow volume.

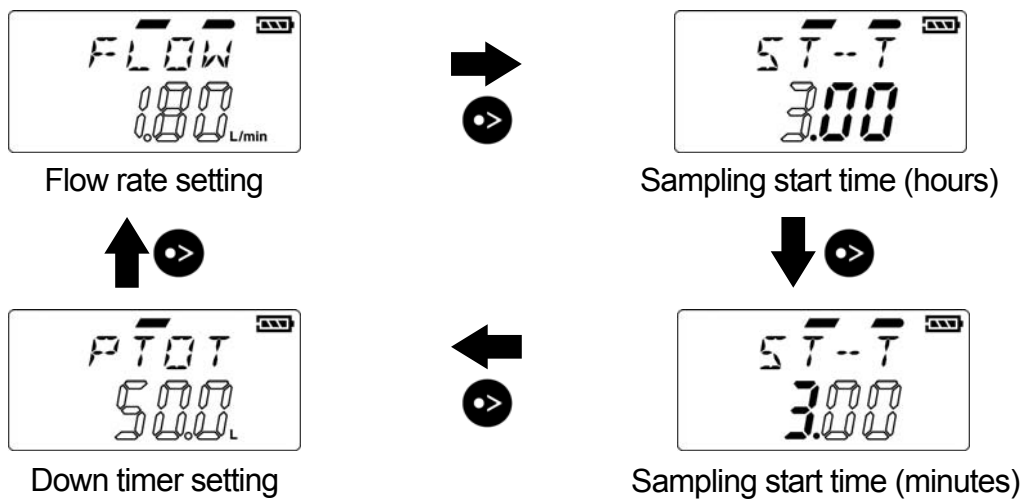

Each press of the MODE key in the setup screen switches the screen cyclically as follows: flow rate setting → sampling start time (hours) → sampling start time (minutes) → volume timer → flow rate setting.

After entering each of the settings, press the START/STOP key. The display value lights, and the SET segment of the mode display bar goes out to indicate that setup is complete.

Pressing the START/STOP key again starts pump operation in the volume timer mode. The operation display LED flashes (orange), the "timer standing by" icon is displayed on screen, and the remaining sampling start time is displayed.

* If the START/STOP key is pressed when the start time is set to "0.00", pump operation starts immediately.



Pressing the UP key switches the screen cyclically as follows: flow volume setting → volume timer → remaining sampling start time. Pressing the DOWN key switches the screen in the reverse direction.

Pump operation starts when the remaining sampling start time reaches "0.00". During pump operation, the operation display LED flashes (green), the pump operation mark lights, and the instantaneous flow rate is displayed.

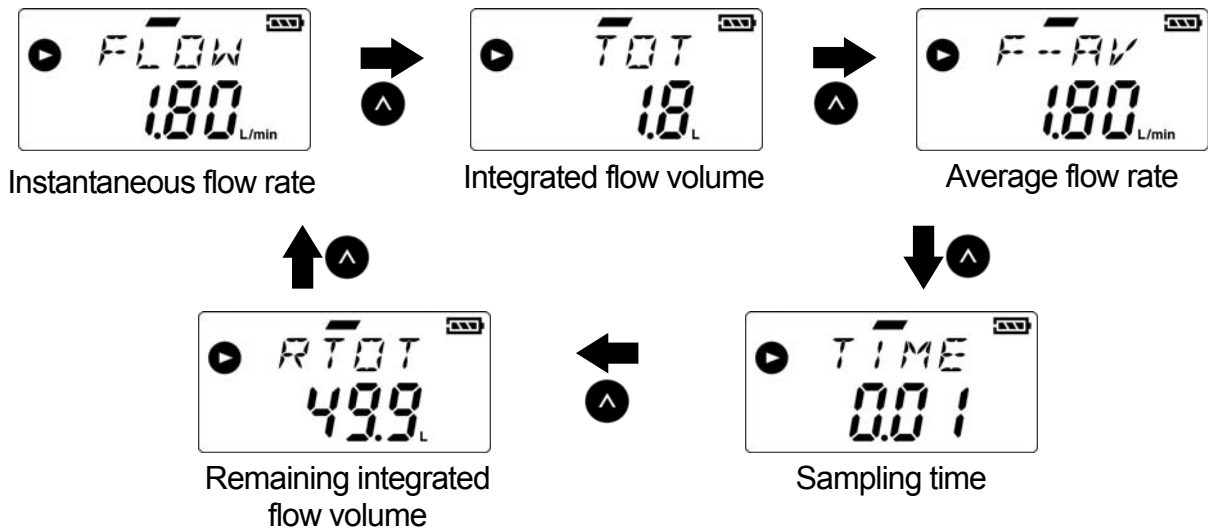

Pressing the UP key during pump operation switches the screen cyclically as follows: integrated flow volume → average flow rate → sampling time → remaining integrated flow volume → instantaneous flow rate. Pressing the DOWN key switches the screen in the reverse direction.

Holding down the KEY LOCK key during pump operation displays the key icon and disables use of the START/STOP key.

* The above items can be checked by using the UP/DOWN key. To cancel the key lock, hold down the KEY LOCK key again. The key icon goes out and the key lock is canceled.

When the preset integrated flow volume is reached, pump operation stops and the integrated flow volume screen is displayed.

For details, see page 26 "After Ending Operation."

* Pump operation can be forcibly stopped by pressing the START/STOP key.

Cycle Timer Mode

The cycle timer mode can be set only from the PC. Communications software (sold separately) is also required.

Press the MODE key until the CY segment of the mode display bar lights.

The flow rate setting is displayed initially in this screen.

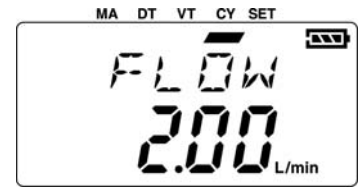

When cycle operation has not been set, the display will be as shown on the right, and the various setting values will not be displayed.

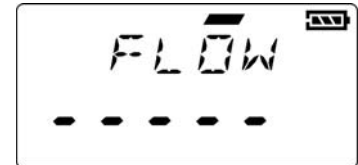

The cycle timer mode allows complex pump operation to be set using communications software (sold separately) on a PC.

The sampling start setting involves only setting of the time. The sampling end time setting, however, involves setting of three conditions, each of the time, duration (i.e. how many minutes later) and the volume timer.

Setups comprising the above settings for up to five measurements can be registered.

CAUTION

In the cycle timer mode, though the time setting is the sampling start condition, sampling is not started automatically.

Sampling is started on condition that the pump is turned ON (power is being supplied to the pump) and that the screen is set to the "sampling standing by" screen by pressing the START/STOP key.

Note that pump operation cannot be started simply with the pump turned ON.

Also, the cycle timer mode is designed to automatically move to the next cycle if cycle operation is not started within two minutes of the preset time. Note also that the pump will not operate according to the preset settings in this case.

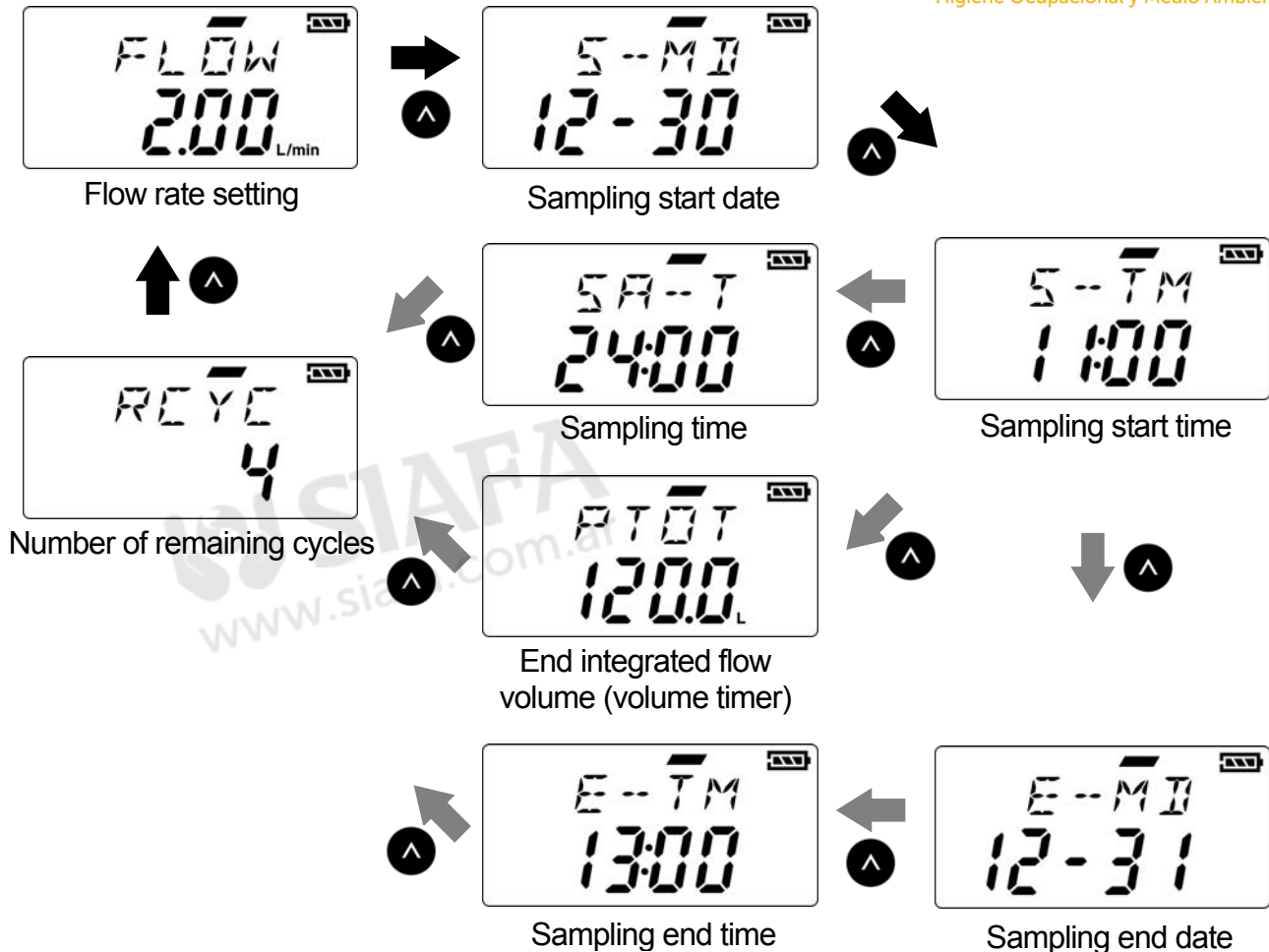

Pressing the UP key switches the screen cyclically as follows: sampling start date → sampling start time → sampling end conditions (3 conditions settable: duration, time and volume, each with a different screen) → number of remaining cycles → flow rate setting. Pressing the DOWN key switches the screen in the reverse direction.

The integrated flow volume and other setup items are sometimes displayed by using the UP/DOWN key. (See page 26 "After Ending Operation.")

Pressing the MODE key in any of the screens changes the mode to memory.

The cycle timer mode can be set only on the PC. So, holding down the MODE key will not change the screen to the setup screen.

Pressing the START/STOP key starts pump operation in the cycle timer mode.

The operation display LED flashes (orange), the "timer standing by" icon is displayed on screen, and the remaining sampling start time is displayed.



Note that cycle operation can start only from this screen!!

* "WAIT" starts flashing when the remaining time counts down to two minutes. If the START/STOP key is pressed to cancel pump operation in this state ("WAIT" flashing), this cycle is not performed and operation moves to the next cycle.

Pressing the UP key switches the screen cyclically as shown above: flow rate setting → sampling start date → sampling start time → sampling end conditions (3 conditions settable: duration, time and volume, each with a different screen) → number of remaining cycles → remaining sampling start time. Pressing the DOWN key switches the screen in the reverse direction.

Pump operation starts when the remaining sampling start time reaches "0.00".

During pump operation, the operation display LED flashes (green), the pump operation mark lights, and the instantaneous flow rate is displayed.

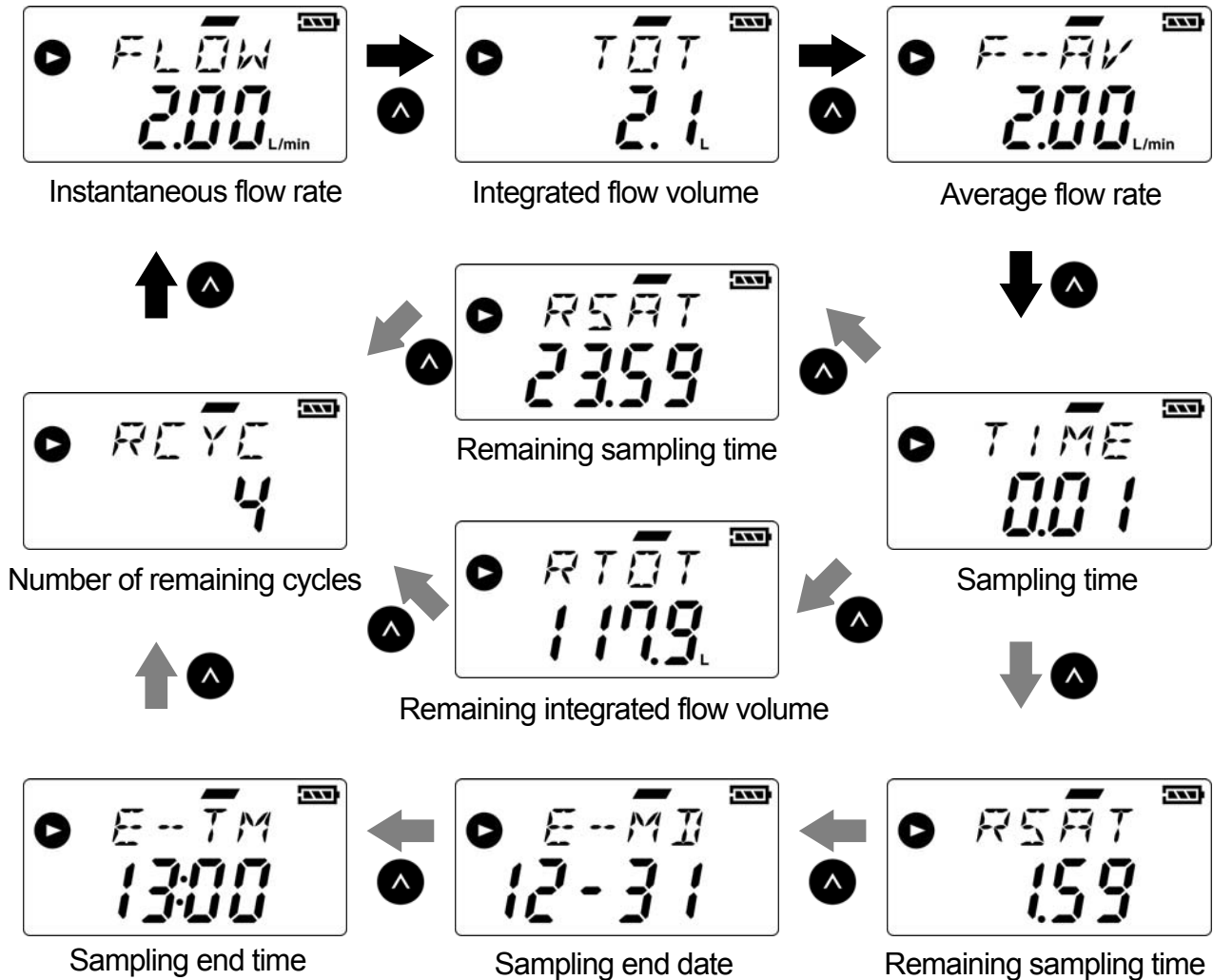

Pressing the UP key switches the screen cyclically as follows: integrated flow volume → average flow rate → sampling time → remaining time or integrated flow volume up to sampling end conditions → number of remaining cycles → instantaneous flow rate. Pressing the DOWN key switches the screen in the reverse direction.

Holding down the KEY LOCK key during pump operation displays the key icon and disables use of the START/STOP key.

* The above items can be checked by using the UP/DOWN key.

To cancel the key lock, hold down the KEY LOCK key again. The key icon goes out and the key lock is canceled.

When the preset sampling end conditions are reached, pump operation stops and the integrated flow volume screen is displayed.

For details, see page 26 "After Ending Operation."

* Pump operation can be forcibly stopped by pressing the START/STOP key.

Numeric Value OVER Display

The following caution screens are displayed when the integrated flow volume, sampling time and instantaneous flow rate exceed fixed numeric values during operation in their respective modes.

Integrated Flow Volume

When integrated flow volume exceeds 9999.9 L (on the MP-Σ30N II, 999.99 L) the OVER icon flashes, and displayed one digit increases. (9999.9 L → 10000 L, on the MP-Σ30N II, 999.99 L → 1000.0 L)

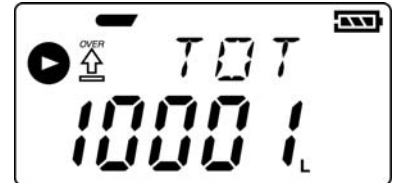

When the integrated flow volume exceeds the maximum display volume 99999 L (on the MP-Σ30N II, 9999.9 L), the numeric value flashes without being incremented beyond this value. The mini pump continues to operate, however, numeric values are not incremented and the integrated flow volume cannot be measured. The average flow rate in this instance also cannot be measured.

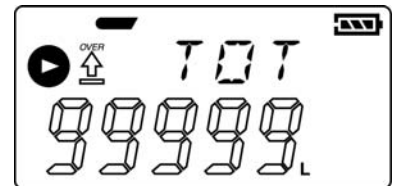

Sampling Time

When the sampling time exceeds 999 hours and 59 minutes, the OVER icon and numeric value flash. The mini pump continues to operate, however, numeric values are not incremented beyond this value and the sampling time cannot be measured.

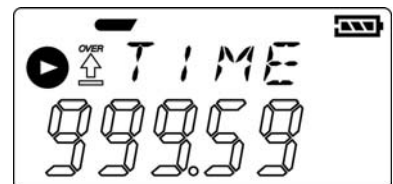

Instantaneous Flow Rate

When the instantaneous flow rate exceeds the maximum display value, the OVER icon and numeric value flash. Numeric values are not incremented beyond this value.

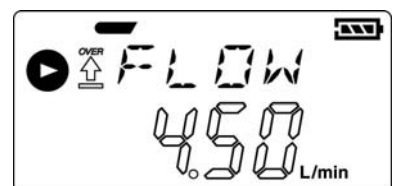

Maximum display values for instantaneous flow rate

MP-Σ30N II	0.750 L/min
MP-Σ300N II	4.50 L/min
MP-Σ500N II	6.00 L/min
MP-Σ100HN II	2.50 L/min

After Ending Operation

When the START/STOP key is pressed, pump operation stops, and the integrated flow volume screen is displayed.

* If an error occurs, the error No. is displayed and the operation display LED flashes (red).

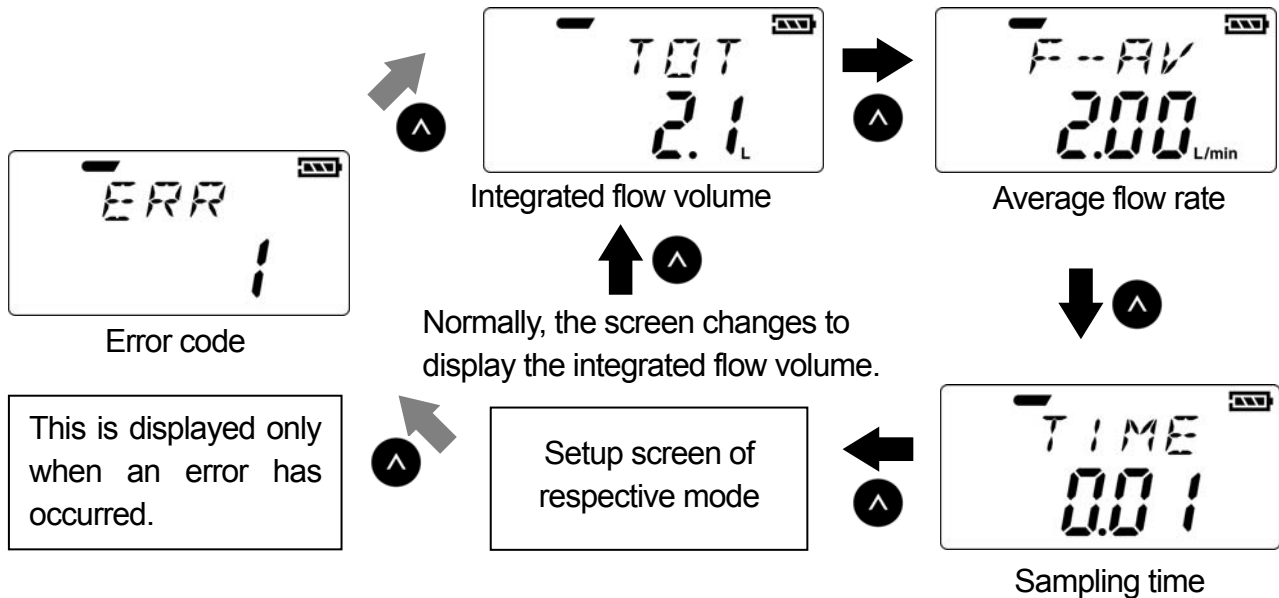

Pressing the UP key switches the screen cyclically as follows: average flow volume → sampling time → setup screen of respective mode → integrated flow volume. Pressing the DOWN key switches the screen in the reverse direction.

The (error code), integrated flow volume, average flow rate, and sampling time are collectively called the "last data," and are displayed only in the operation mode that measurement was last performed.

(For example, when operation was last performed in the down timer mode, the last data is displayed only in the down timer mode and not in other modes, such as the manual mode.)

The last data is the same as LOG 0 in the memory function described on the following page. Pressing the UP/DOWN key returns the screen to flow volume setting or other regular screens.

If an error code is displayed, see page 34 "Errors."

Memory

Press the MODE key until the MEM screen is displayed.

In this screen, you can view past data (logs) by pressing the START/STOP key.

"LOG 0" is displayed in the initial screen. Logs for the last ten measurements (to LOG 9) can be viewed provided that logs are stored in memory.

The date on this screen is the date when the pump was first operated.

* If logs are not stored in memory even after pump operation, contact your Sibata agent.

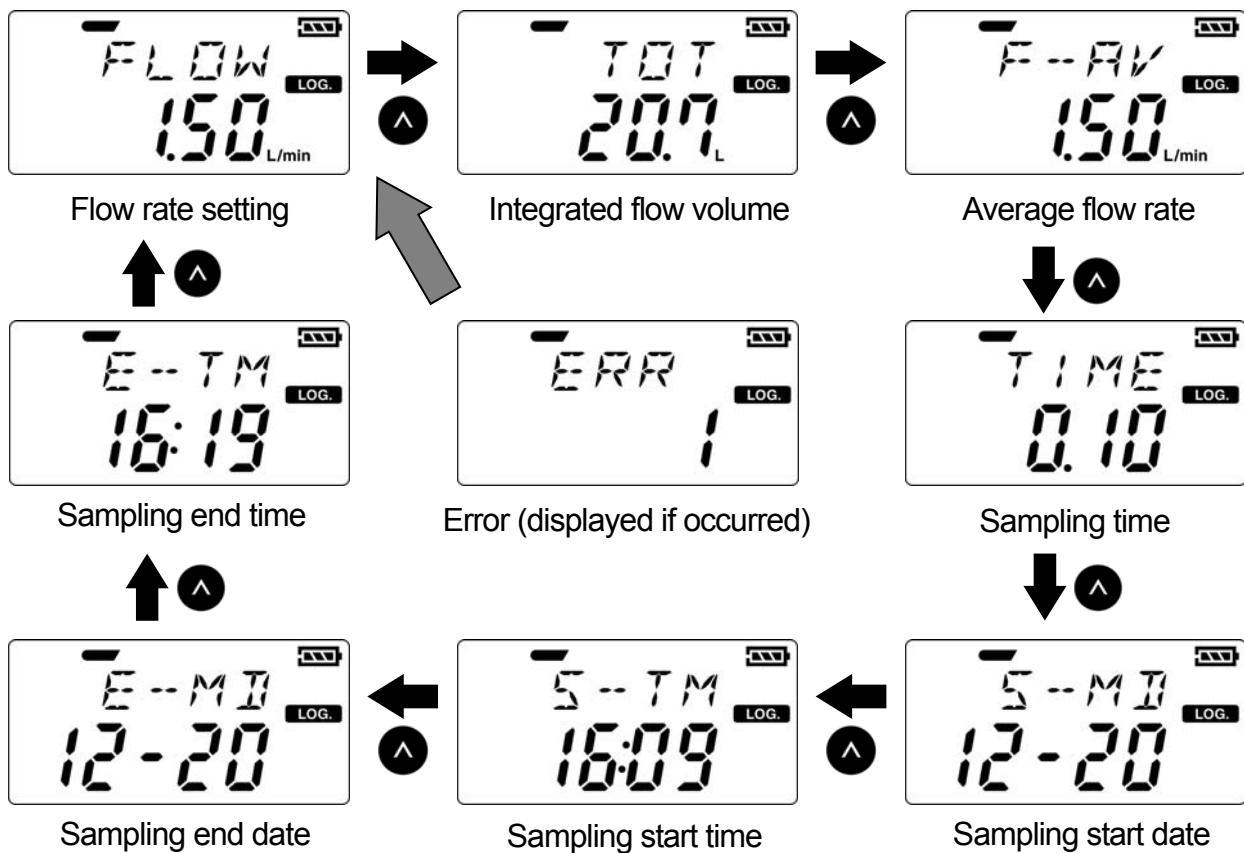

Pressing the UP key in each log screen switches the screen cyclically and returns to the log screen as follows: flow rate setting → error (displayed if occurred) → integrated flow volume → average flow rate → sampling time → sampling start date → sampling start time → sampling end date → sampling end time. Pressing the DOWN key switches the screen in the reverse direction.

Which mode the pump was operated in can be checked by the mode display bar at the top of each screen.

Pressing the MODE key at any respective position advances the screen to the next log screen.

Pressing the START/STOP key in any of the above screens returns the screen to the MEM screen.

Up to 10 logs can be checked on the mini pump body. However, up to 99 logs can be viewed on a PC by using communications software (sold separately).

The last data displayed after pump operation stops is LOG 0.

Extra Menu

LED display conventions



Flashing



Lit

Press the MODE key until the EXTR screen is displayed.

In this screen, you can enter the extra menu if you press the START/STOP key, and the clock (time) is displayed.

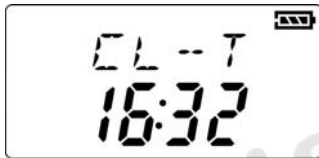
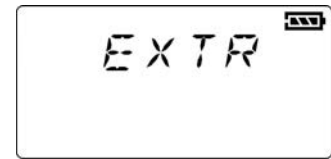

Clock (time)



Flow rate conversion temperature

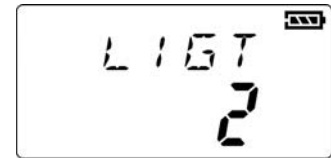

Backlight ON setting



Power ON time



Data deletion

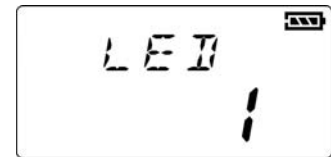

Operation display LED ON setting

Pressing the MODE key switches the screen cyclically: flow rate conversion temperature → backlight ON setting → operation display LED ON setting → data deletion → power ON time → clock (time).

Clock

Pressing the UP key in the clock (time) screen switches the screen cyclically: year → date → time.

Pressing the DOWN key switches the screen in the reverse direction.

Pressing the MODE key in any of the screens changes the screen to the flow volume conversion temperature.

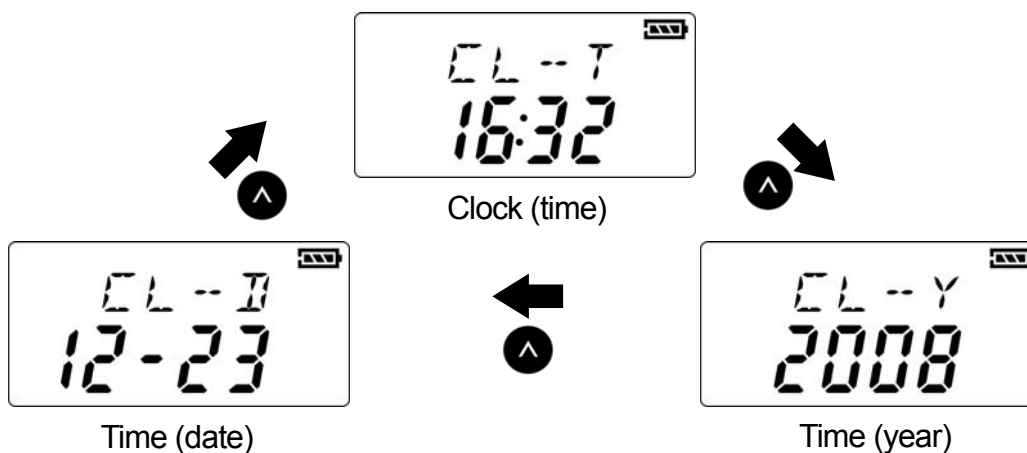

The clock can be set by holding down the MODE key in the respective screen. In the setup screen, the SET segment of the mode display bar lights and the value that can be set flashes. Set the value by using the UP/DOWN key.

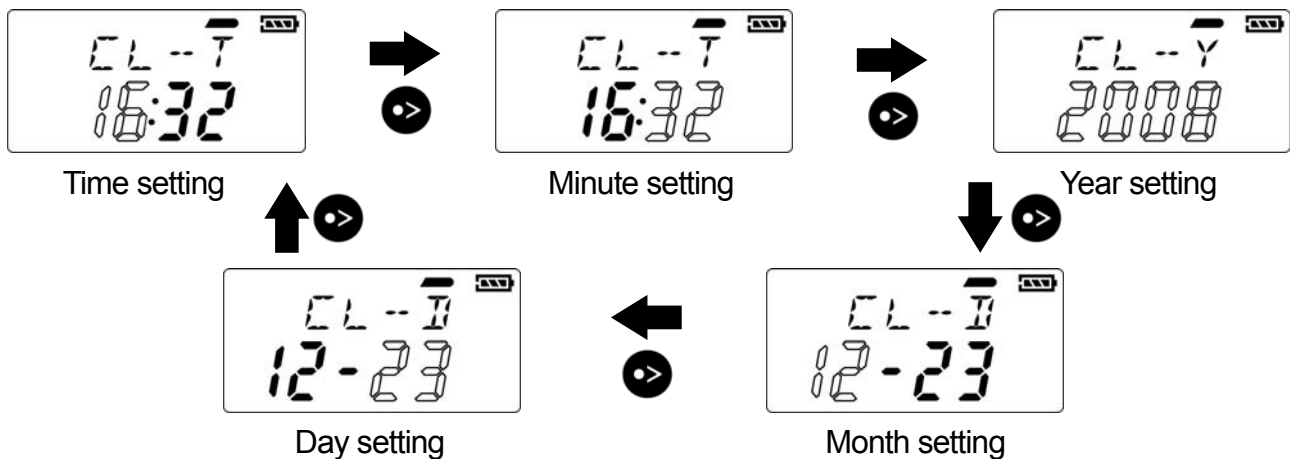

Pressing the MODE key changes the screen cyclically as follows: time → minutes → year → month → day → time. In each of the relevant screens, press the START/STOP key. The display value lights, and the SET segment of the mode display bar goes out to indicate that setup is complete.

* If the time deviates greatly or cannot be set after the clock is set, contact your Sibata agent.

Flow Rate Conversion Temperature

The flow rate conversion temperature is displayed. The default temperature is 25.0°C. Holding down the MODE key causes the SET segment of the mode display bar to light and the value to flash.

The value can be switched between 20.0°C and 25.0°C by pressing the UP/DOWN key.

In each of the relevant screens, press the START/STOP key. The display value lights, and the SET segment of the mode display bar goes out to indicate that setup is complete.

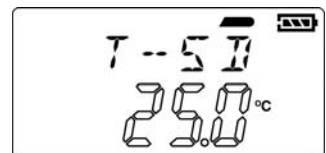

Backlight ON Setting

The backlight ON condition can be set. The default is 2.

Holding down the MODE key causes the SET segment of the mode display bar to light and the value to flash. The value can be changed in the range 0 to 2 by pressing the UP/DOWN key.

0: OFF at all times

1: ON at all times

2: Backlight turns OFF if no buttons are pressed for 30 seconds.

(The number of seconds can be set at "Backlight ON Time" on page 32.)

In each of the relevant screens, press the START/STOP key. The display value lights, and the SET segment of the mode display bar goes out to indicate that setup is complete.

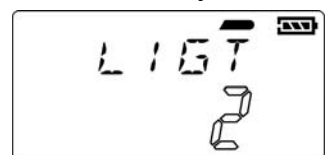

Operation Display LED ON Setting

The operation display LED can be set ON or OFF. The default is 1.

Holding down the MODE key causes the SET segment of the mode display bar to light and the value to flash. The value can be switched between 0 and 1 by pressing the UP/DOWN key.

0: OFF (LED does not turn ON at any item.)

1: ON

In each of the relevant screens, press the START/STOP key. The display value lights, and the SET segment of the mode display bar goes out to indicate that setup is complete.



Data Deletion

The log data (memory) on the mini pump can be deleted and settings can be returned to their defaults.

Pressing the UP key after entering the DEL screen switches the screen cyclically as follows: log data deletion → return to defaults → DEL screen. Pressing the DOWN key switches the screen in the reverse direction.

Pressing the MODE key in any of the screens changes the screen to the power ON time.

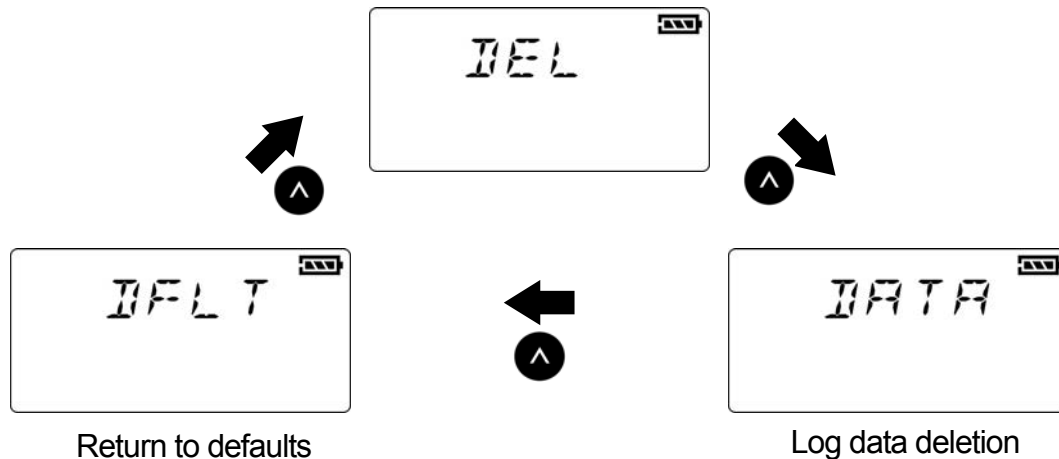

DATA indicates that all registered log data are to be deleted.

DFLT indicates that all pump settings are to be returned to their defaults.

In each of the relevant screens, hold down the MODE key to scroll "PUSH START KEY". In this screen, pressing the MODE key cancels the operation.

Press the START/STOP key to execute the operation.

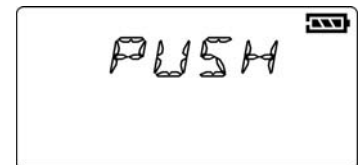

When "END" is displayed, this indicates that deletion is completed.

* Note that logs or settings cannot be restored once they have been deleted.

* When settings have been returned to their defaults, the flow volume calibration value (see page 32 "Calibration") is also returned to its default.

* Do not turn OFF the pump while data is being deleted. Doing so might cause malfunction.

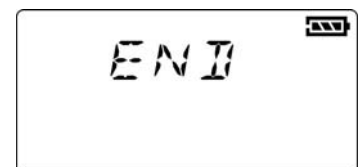

Note that, should some nonconformity occur, SIBATA does not assume any liability whatsoever for compensation of data or content that could not be acquired or logged as a result, loss of data or other content, and other direct and indirect damages relating to the preceding. We recommend using communications software (sold separately) to periodically back up data as a precaution against malfunction or accidents. We also recommend preliminary operation checks and other periodic inspection.

Power ON Time

The time elapsed since the mini pump was turned ON is displayed. Only the MODE key is functional in this screen.

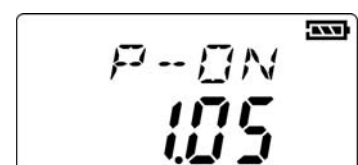

Submenus

LED display conventions



Submenus are provided so that you can make setups in more detail.

To enter submenus, turn the pump ON with the MODE key held down. The POW screen will be displayed.

The following items can be checked and set.

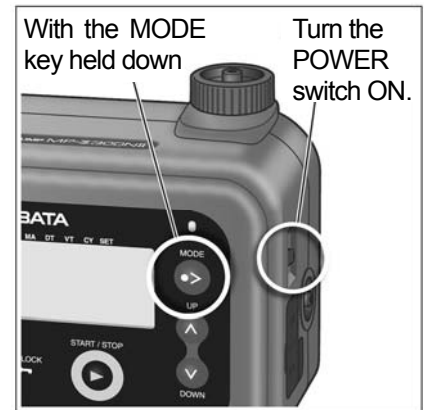

Pressing the MODE key with POW (voltage value) displayed switches the screen cyclically as follows: current value → motor operating time → backlight ON time → calibration → voltage value.

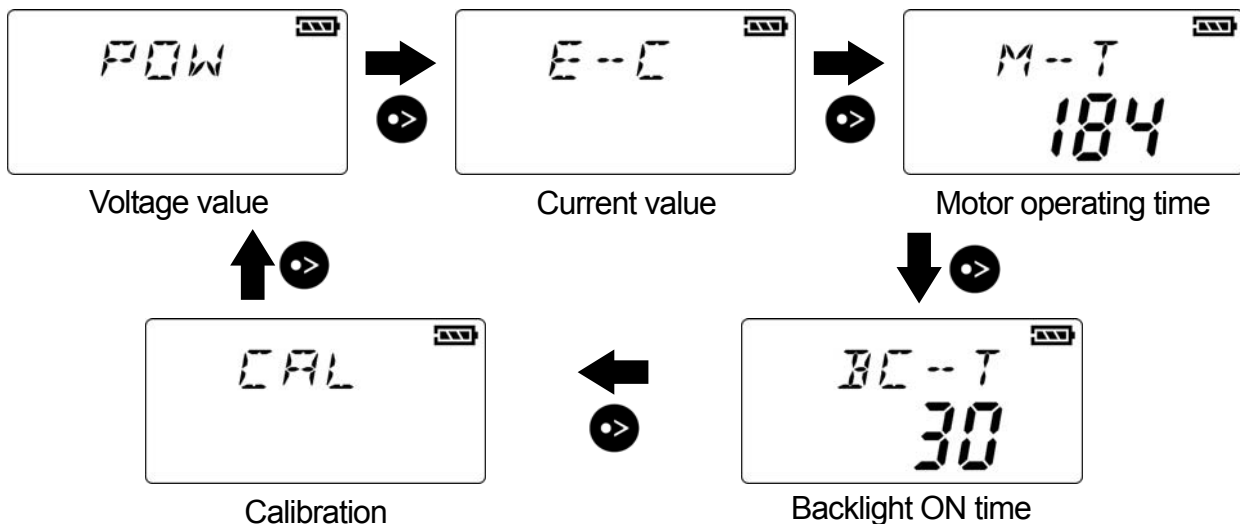

Voltage Value

Pressing the START/STOP key operates the pump for ten seconds. The voltage during pump operation is displayed.

* The flow volume at this time is the flow volume set in the manual mode. (See page 17 "Manual Mode.")



Current Value

Pressing the START/STOP key operates the pump for ten seconds. The current consumption during pump operation is displayed. Current is displayed in mA units.

* The flow volume at this time is the flow volume set in the manual mode. (See page 17 "Manual Mode.")

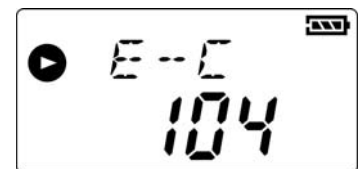

Motor Operating Time

This is the total operating time of the pump. The motor's service life is about 2,000 hours of operation. After 2,000 hours of operation is exceeded, consider performing maintenance on the pump.

* 2,000 hours of operation is only a guideline. This figure may become shorter depending on the operating environment.

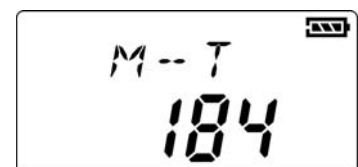

Backlight ON Time

The time up to when the backlight turns OFF after a button on the control panel is pressed can be set. (See page 29 "Backlight ON Setting.") The default is 30 seconds.

Holding down the MODE key in this screen causes the SET segment of the mode display bar to light and the value to flash. In this state, the value can be set. Change the value by using the UP/DOWN key. After changing the value, press the START/STOP key. The display value lights, and the SET segment of the mode display bar goes out to indicate that setup is complete.

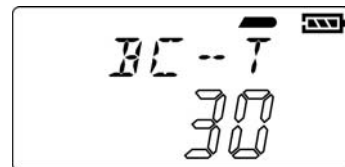

Calibration

Calibration with suction holder connected to suction port in order to do highly precise measurement. Using Sibata's flow calibrator FC-M1 as a standard flow meter allows easier correction. Refer to the instruction of flow calibrator FC-M1 for more detail.

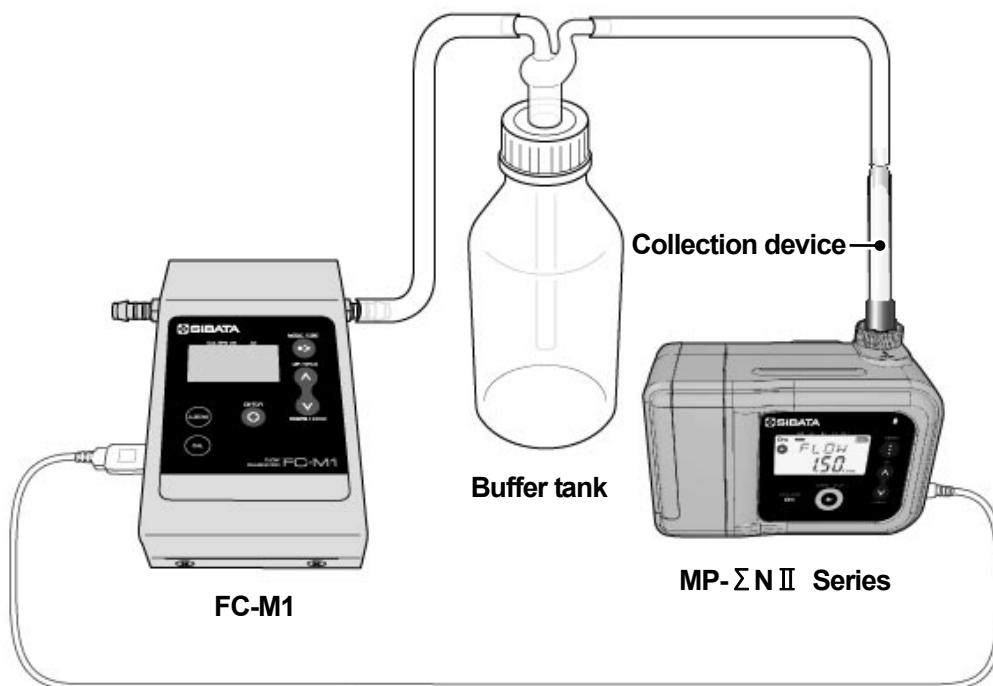

FC-M1 and USB cable allows the automatic operation as below:

Pressing the UP/DOWN key after entering the CAL screen enters the flow volume calibration mode.

* **Calibration here is 1-point calibration. So, accuracy will deviate with other flow rate. To return to the original calibration value, set the defaults. (See page 30 "Data Deletion.")**

Press the START/STOP key in the FADJ screen. The flow rate conversion temperature is displayed flashing. The value can be switched between 20.0°C and 25.0°C by pressing the UP/DOWN key. Pressing the MODE key in this screen cancels calibration and returns to the FADJ screen.

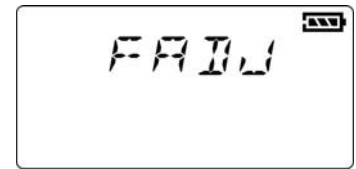

After setting the flow rate conversion temperature, press the START/STOP key. The flow volume is displayed flashing. Set the flow rate to be calibrated by pressing the UP/DOWN key.

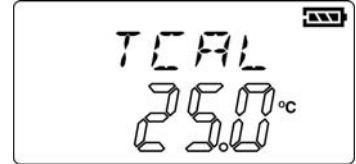

Pressing the START/STOP key offsets the flow rate to zero and starts pump operation. The operation display LED flashes (red), the pump operation icon flashes, and no other operations are accepted for one minute. When the operation display LED starts flashing (green) and the pump operation icon stops flashing and lights, perform measurement using a standard flow meter.

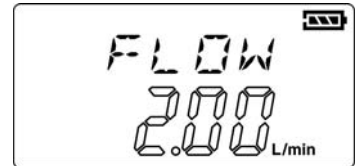
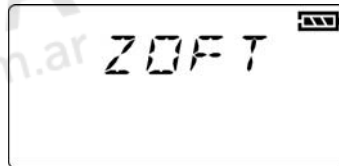

When measurement is completed, press the START/STOP key to stop pump operation.

Match the flow rate value to the number indicated on the standard flow meter by pressing the UP/DOWN key.

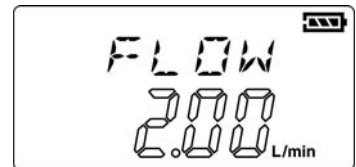

When the above calibration procedure is finished, press the START/STOP key. "END" is displayed and the screen returns to the FADJ screen.

* There is no need to calibrate the flow rate each time that the pump is used.

* Do not turn the pump OFF during calibration. Doing so might cause malfunction.

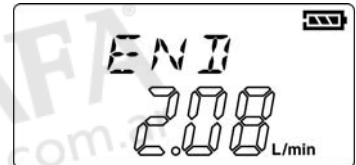

Errors

Immediately stop operation if an error occurs during pump operation. If an error occurs, the error No. is displayed and the operation display LED flashes (red).

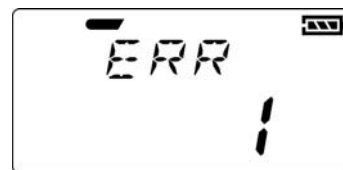

- 1: The difference between the set flow rate and the instantaneous flow volume displays has reached or exceeded $\pm 20\%$.
- 2: The power voltage has fallen below 6 V.
- 3: The motor current consumption has reached or exceeded 500 mA.

These errors are also stored in the log.

With ERR2, the power source sometimes is interrupted and the display goes out. When the power is turned back ON in this case, the operation display LED will flash (red) and "ERR2" will be displayed. In this state, press any button. The regular screen will be displayed and operations can be performed. If the power is turned OFF without pressing any button and the power is turned back ON again, "ERR2" will be displayed again.

Troubleshooting

Symptom	Cause	Remedy
No display after power ON	Battery is not connected.	Install LI-10N Battery Unit or DB-10N Dry Battery Unit, or run on an AC power source.
	Battery power of LI-10N Battery Unit has dropped.	Charge LI-10N with QC-10N Quick Charger.
	DB-10N Dry Battery Unit has no batteries inside.	Insert 8 new AA batteries inside at specified positions.
	The batteries inside DB-10N Dry Battery Unit are running low.	
	The AC adapter plug is disconnected during use on an AC power source.	Connect the QC-10N (AC adapter provided) or PA-1203 AC adapter correctly into the 100 to 240VAC power outlet. Also, check the connector on the MP-ΣN II side.
Display appears however pump does not operate or pump operation is strange.	Liquid is being sucked in. (See note * below.)	Repair and adjustments are required. Contact your Sibata agent.
	Battery power is low, and  is displayed on screen. (when LI-10N Battery Unit is used)	Replace or charge battery, or run on an AC power source.

Symptom	Cause	Remedy
Pump operates, but flow rate does not increase or stabilize.	Filter element is clogged.	Replace filter element.
	Exclusive suction holder is not used (MP-Σ30N II only).	When measuring under 0.150 L/min or less, use provided ultra low flow rate suction holder.
	Sampling tube is broken.	Replace tube.
		Change how tube is connected.
	There is an obstacle on exhaust side.	Remove obstacle.
Suction pressure is outside specification range.	See if suction pressure is within specification range. (See pages 13 and 36, 37)	
Pump stops during sampling.	<p>Check the error No. displayed on screen.</p> <p>ERR1: Difference between set flow rate and displayed instantaneous flow rate has reached or exceeded $\pm 20\%$.</p> <p>ERR2: Power voltage has fallen below 6 V (due to power failure or disconnection of electric plug from the power source.)</p> <p>ERR3: Motor current consumption has reached or exceeded 500 mA.</p>	Remove cause of error according to error No., and retry use. If problem is not solved, contact your Sibata agent.
Internal clock setting fails even though internal clock has been set.	Clock time deviates considerably, or the time registered by the memory function is a strange value.	Repair and adjustments are required. Contact your Sibata agent.
No logs in memory.	Logs are not stored in memory even after pump operation.	Repair and adjustments are required. Contact your Sibata agent.
Backlight does not turn ON.	The backlight is set not to turn ON.	Refer to backlight ON setting in extra menu (See page 29).
Operation display LED does not turn ON.	The operation display LED is set not to turn ON.	Refer to operation display LED ON setting in extra menu (See page 29).
When using the LI-10N Battery Unit that has finished charging, the battery quickly runs out.	<p>The LI-10N Battery Unit is over discharged.</p> <ul style="list-style-type: none"> •The pump was stored with the power switch ON. •The battery was not used for a long time. 	When the QC-10N Quick Charger is used to charge the LI-10N and indicates that it is fully charged within 10 minutes, re-power the QC-10N, and charge it again. Also after it is charged, use the voltage confirmation function of the QC-10N and confirm that the charge has finished properly (See QC-10N operation manual).
	The life of lithium-ion rechargeable battery has expired.	Purchase and replace the LI-10N Battery Unit.

* A frequent problem is the impinger connected in reverse. Pay attention to orientation when connecting piping. (See page 13 "Installation and Piping Methods, When Using an Impinger.")

Main Specifications

Pump Unit

Item Code	090860-034	090860-304
Model	MP-Σ30N II	MP-Σ300N II
Operable Flow Rate Range	0.050 to 0.500 L/min	0.50 to 3.00 L/min
Display Range of Instantaneous Flow Rate	0.000 to 0.750 L/min	0.00, 0.20 to 4.50 L/min
Constant Flow Rate Ranges	0.1 L/min: 0 to 10.0 kPa 0.2 L/min: 0 to 9.0 kPa 0.3 L/min: 0 to 9.0 kPa 0.4 L/min: 0 to 8.0 kPa 0.5 L/min: 0 to 7.0 kPa	0.5 L/min: 0 to 10.0 kPa 1.0 L/min: 0 to 7.0 kPa 2.0 L/min: 0 to 6.0 kPa 3.0 L/min: 0 to 5.0 kPa
Accuracy of Constant Flow Rate	Within $\pm 5\%$ of the set flow rate	
Range of Integrated Flow Volume Setting (Volume Timer)	0.00 to 999.99 L	0.0 to 9999.9 L
Display Range of Integrated Flow Volume	0.00 to 9999.9 L	0.0 to 99999 L
Display Range of Set Time	0.00 to 999.59 (time: minute)	
Time Setting / Display	Year / month / day, hour : minute	
Built-In Flow Meter	Mass-flow sensor	
Pump Type	Double diaphragm type	
Material	Pump head: ABS / POM / TPU, diaphragm: EPDM, valve: EPDM, case: PC	
Mode	Manual, down timer, volume timer, cycle timer	
Display	Liquid crystal display device (with backlighting)	
Communications (USB)	Loading and setting by exclusive communications software	
Suction / Exhaust Port Diameter	O.D. 6 mm and 8 mm (tube used: I.D. 5 mm dia. and 7 mm dia.)	
Range of Operating Temperature / Humidity	0 to 40 °C 10 to 90% rh (no condensation)	
Electric Power Source	Lithium-ion rechargeable battery (sold separately), AA dry batteries (optional), AC adapter (optional)	
Operating Time (when a lithium-ion rechargeable battery is used in a no-load state)	over 60 hours	1.0 L/min: over 50 hours 2.0 L/min: over 45 hours 3.0 L/min: over 35 hours
Operating Time (when AA alkaline dry cells are used in a no-load state)	over 30 hours	1.0 L/min: over 25 hours 2.0 L/min: over 22 hours 3.0 L/min: over 17 hours
Dimensions	145 W × 67 D × 95 H mm (excluding protrusions, including lithium-ion rechargeable battery)	
Weight	0.65 kg (including lithium-ion rechargeable battery)	
Accessories	Suction holder for ultra low flow rate (for MP-Σ30N II only)	

* The above stated operable flow rate range, constant flow rate range, and accuracy of constant flow rate are for 1 atmospheric pressure. It may be short of the stated performance when it is high altitude and low atmospheric pressure.

* The operating time is the case for at 25°C. The life of the battery varies depending on the ambient temp., usage record, and suction pressure.

* When the MP-Σ30N II is used at flow rates lower than 0.1 L/min, the instantaneous flow rate displayed may deviate momentarily.

Pump Unit

Item Code	090860-504	090860-104
Model	MP-Σ500N II	MP-Σ100HN II
Operable Flow Rate Range	2.00 to 5.00 L/min	0.30 to 1.50 L/min
Display Range of Instantaneous Flow Rate	0.00, 0.50 to 6.00 L/min	0.00, 0.10 to 2.50 L/min
Constant Flow Rate Ranges	2.0 L/min: 0 to 10.0 kPa 3.0 L/min: 0 to 8.0 kPa 4.0 L/min: 0 to 5.0 kPa 5.0 L/min: 0 to 3.0 kPa	0.3 L/min: 2.0 to 35.0 kPa 0.5 L/min: 2.0 to 33.0 kPa 0.7 L/min: 1.0 to 25.0 kPa 1.0 L/min: 1.0 to 22.0 kPa 1.5 L/min: 1.0 to 10.0 kPa
Accuracy of Constant Flow Rate	Within $\pm 5\%$ of the set flow rate	
Range of Integrated Flow Volume Setting (Volume Timer)	0.0 to 9999.9 L	
Display Range of Integrated Flow Volume	0.0 to 99999 L	
Display Range of Set Time	0.00 to 999.59 (time: minute)	
Time Setting / Display	Year / month / day, hour : minute	
Built-In Flow Meter	Mass-flow sensor	
Pump Type	Double diaphragm type	
Material	Pump head: ABS / POM / TPU, diaphragm: EPDM, valve: EPDM, case: PC	
Mode	Manual, down timer, volume timer, cycle timer	
Display	Liquid crystal display device (with backlighting)	
Communications (USB)	Loading and setting by exclusive communications software	
Suction / Exhaust Port Diameter	O.D. 6 mm and 8 mm (tube used: I.D. 5 mm dia. and 7 mm dia.)	
Range of Operating Temperature / Humidity	0 to 40 °C 10 to 90% rh (no condensation)	
Electric Power Source	Lithium-ion rechargeable battery (sold separately), AA dry batteries (optional), AC adapter (optional)	
Operating Time (when a lithium-ion rechargeable battery is used in a no-load state)	2.0 L/min: over 36 hours 3.0 L/min: over 30 hours 4.0 L/min: over 24 hours 5.0 L/min: over 18 hours	1.0 L/min: over 48 hours (at 3kPa)
Operating Time (when AA alkaline dry cells are used in a no-load state)	2.0 L/min: over 18 hours 3.0 L/min: over 15 hours 4.0 L/min: over 12 hours 5.0 L/min: over 9 hours	1.0 L/min: over 24 hours (at 3kPa)
Dimensions	145 W × 67 D × 95 H mm (excluding protrusions, including lithium-ion rechargeable battery)	
Weight	0.65 kg (including lithium-ion rechargeable battery)	

* The above stated operable flow rate range, constant flow rate range, and accuracy of constant flow rate are for 1 atmospheric pressure. It may be short of the stated performance when it is high altitude and low atmospheric pressure.

* The operating time is the case for at 25°C. The life of the battery varies depending on the ambient temp., usage record, and suction pressure.

LCD Screen Indications and Meanings

Regular Screens		
CLD-D	Current date	Displays the date of the internal clock.
CLD-T	Current time	Displays the time of the internal clock.
CLD-Y	Current year	Displays the year of the internal clock.
DATA	Log deletion screen	Displays deletion of all logs.
DEL	Deletion screen	Displays log deletion and setting of defaults.
DFLT	Default settings	Indicates the fact that you are returns settings to their defaults.
E-MD	Measurement end date	Displays the date at the end of sampling.
END	End	Indicates the fact that data deletion has ended.
ERR	Error No.	Displays the error and details of the error by an error No.
E-TM	Measurement end time	Displays the time at the end of sampling.
EXTR	Extra menu	Menu for entering various setup menus (e.g. clock setting).
F-AV	Average flow volume	Displays the average flow rate during sampling.
FLOW	Flow rate setting, instantaneous flow rate	Displays the set flow rate before measurement and the instantaneous flow rate during measurement.
LED	Operation display LED setting	Displays the LED ON setting.
LIGT	Backlight ON setting	Displays the backlight ON setting.
LOG 0-9	Log No.	Displays each log by a No. in the log screen.
MEM	Past log menu	Menu for entering the log menu
PC-	PC connection screen	Indicates that you are connecting to the PC by a USB cable.
P-ON	Power ON time	Displays the time that the pump was turned ON.
PTOT	Volume timer setting	Displays the integrated flow volume set by the volume timer.
RCYC	Remaining number of cycles	Displays the remaining number of cycles (remaining number of measurements) by the cycle timer.
RSAT	Remaining measurement time	Displays the remaining time up to end of measurement.
RTOT	Remaining measurement volume	Displays the remaining integrated flow volume up to end of measurement.
SA-T	Set sampling time	Displays the sampling start time.
S-SMD	Measurement start date	Displays the sampling start date in the cycle timer mode.
S-TM	Measurement time	Displays the sampling start time in the cycle timer mode.
ST-T	Pump operation start time	Displays the preset sampling start time.
TIME	Actual sampling time	Displays the actual sampling time.
TOT	Integrated flow volume	Displays the actual integrated flow volume value.
T-SD	Flow volume conversion temperature display	Displays the temperature conversion value of the flow volume.
VER	Version information	Displays the version information of this product.
WAIT	Remaining measurement start time	Displays "measurement standing by" and the remaining time up to start of measurement.
Submenus		
BC-T	Backlight OFF time setting	Indicates that you are setting the time until the backlight is turned OFF.
CAL	Calibration screen	Screen for entering the calibration mode
E-C	Current value	Displays the current consumption
END	End	Indicates that calibration has ended.
FADJ	Flow rate calibration screen	Displays flow rate calibration.
FLOW	Calibrated flow rate, instantaneous flow rate	Displays the flow rate during calibration, and the instantaneous flow rate during pump operation.
M-T	Motor operating time	Displays the continuous motor operating time of this product.
POW	Battery voltage	Displays the battery voltage.
TCAL	Flow rate conversion temperature setting at	Displays the flow rate conversion temperature setting at flow rate calibration.
ZOFT	Zero offset	Indicates that zero offset is being performed at flow rate calibration.

Options (Including Consumables)

- LI-10N Battery Unit [Item Code: 080860-010]
- DB-10N Dry Battery Unit [Item Code: 080860-011]
- QC-10N Quick Charger [Item Code: 080860-110]
- PA-1203 AC adapter [Item Code: 080000-1203]
- Suction port set for MP-ΣN/MP-ΣN II [Item Code: 080860-002]
- Soft case for MP-ΣN/MP-ΣN II [Item Code: 080860-003]
- VFE-3 Filter Elements (packet of 5) [Item Code: 080860-001]

Maintenance

To sustain the flow volume precision of this product, we recommend periodic inspection (charged). We recommend inspection at our company once every year. Also, replace the filter element periodically.

Warranty and Repair

This product shall be repaired free-of-charge should it malfunction within one year of purchase. When asking for repair, be sure to directly contact the dealer of purchase. Consumables provided with this product fall outside of the scope of this Warranty. Repair of the product itself also shall fall outside of the scope of this Warranty if any of the following causes it to malfunction:

- Faults or damage resulting from incorrect use
- Faults or damage resulting from repairs or modifications implemented by parties other than Sibata
- Faults or damage resulting from fires or natural disasters, such as earthquakes
- Faults or damage occurring after purchase due to relocation, movement, falling, or vibration
- Faults or damage resulting from the use of consumable items not specified by Sibata
- Any case in which the date of purchase has not been entered on the warranty, the warranty has not been stamped, or the warranty items have been corrected

■ Requesting the Repair of Products Used in Environments Exposed to Asbestos (Request)

In order to prevent harm to customers and repair staff due to asbestos exposure, we would like your cooperation when you request the repair of products that have been used in environments exposed to asbestos. Please read the following before requesting repairs.

- 1: Remove any asbestos from the product before sending it for repairs. After removing asbestos, place the product and any accessories in a double-sealed, transparent, waterproof material (such as a strong plastic bag) and pack it in a box. When sealing the bag, make sure that the product serial number and the number of accessories can be confirmed from the outside.

- 2: Write "AS" clearly in the "Fault Description and Request Details" column of the "Repair Request Form." If there is no such description with the product, you may be asked by our sales representative to confirm whether there was any asbestos exposure.
- 3: When the product to be repaired is sent to us by courier, then, in addition to the model number, add "AS" to the "Comments" or "Description" section of the invoice. This measure is to prevent damage to the sealed bag when the package is unpacked with a cutter.

Note: The above request is applicable to all similar products related to asbestos measurement.

Disclaimer

Should some nonconformity occur during use of this product, SIBATA does not assume any liability whatsoever for compensation of data or content that could not be acquired or logged as a result, loss of data or other content, and other direct and indirect damages (loss of business profit, interruption of business, etc.) relating to the preceding.

SIBATA guarantees repair of production malfunctions under fixed conditions. However, SIBATA does not offer any compensation for loss of or damage to data stored on the product. When asking SIBATA for repair or other services, make a backup of any required data. SIBATA does not assume any liability whatsoever for any damages that may occur accompanying loss or discarding of data due to infringement of precautions described in this manual or neglect to back up data on the part of the customer.

For details of repair after the Warranty has expired, contact your Sibata agent. The product shall be repaired for a fee only if SIBATA judges that repair shall restore its functions, and its functions can be sustained in the future only in accordance with specified methods of use.

When returning this product for repair, fill in the Trouble Notification Sheet and send this sheet together with this product. (See page 41 " Trouble Notification Sheet.")

Disposal of the Product

Dispose of the product in accordance with the disposal laws and regulations of your respective local governing body. The pump body is made almost entirely from plastic (PCB and ABS).

The LI-10N Battery Unit should, if possible, be disposed of by a recycle vendor since it is a lithium-ion rechargeable cell.

Inquiries

If you have any questions about this product, or if there is any other way in which we can be of assistance, contact your Sibata representative.

Trouble Notification Sheet

This sheet is to be filled with information required for the smooth checking and repair of pump malfunctions. Please fill in this sheet in as much detail as possible. Also, attach this sheet when asking for repair. Please fill in the cautions when sending the pump for repair and required cleaning details.

Mini Pump MP-ΣN II Series Trouble Notification Sheet

If the pump malfunctions, make a copy of this sheet, fit it in and contact your Sibata agent.

Entry Date: (y/m/d)

[Product Conditions of Use]

Model : MP-Σ30N II : MP-Σ300N II : MP-Σ500N II : MP-Σ100HN II
Serial No. _____ Date of Purchase: (y/m/d)
Start of Use: (y/m/d)
Frequency of Use : Every day : ___ days/week : ___ days/month : ___ hours/day
Operating Environment Temperature (measured temperature, if possible): ()°C to ()°C
Number of Installed Units: ___ units Application: _____

[Symptoms of Malfunction]

Frequency of Occurrence : Every time : Occasionally : Rarely : Other
(_____)
Start of Malfunction : Since purchase : Within a month : Within a week
: Other
(_____)
Symptoms: (Write in as much detail as possible.) Ex: Backlight does not turn ON even by pressing a key.

[Check Items] (Please choose your answer.)

- Does the LCD display turn ON when the power to the pump body is turned ON? (Yes · No)
- Is the filter element particularly dirty? (Yes · No)
- Is water or other liquid being sucked in? (Yes · No)
- Are there any signs or scratches on the pump body indicating that it has been dropped or impacted? (Yes · No)

[Work Check Items When Asking for Repair]

- : Make a copy of the Trouble Notification Sheet, fill it in and send it together with the pump.
- : If there is the risk that harmful substances (e.g. asbestos) have been sucked into the pump, put this Trouble Notification Sheet in an envelope, and stick this to the outside of the box. Also, be sure to clearly indicate the presence of such substances on the Trouble Notification Sheet. (In case of asbestos sampling, please follow the " ■ Requesting the Repair of Products Used in Environments Exposed to Asbestos (Request) " on page 39.)



www.siafa.com.ar
ventas@siafa.com.ar

011 4684 2232

SIBATA SCIENTIFIC TECHNOLOGY LTD.



1-1-62, Nakane, Soka, Saitama, 340-0005, Japan

TEL:+81-48-933-1582 FAX:+81-48-933-1591

E-mail: overseas@sibata.co.jp

<http://www.sibata.co.jp/english/>

Note) Shape, dimensions, specifications, and other product information are subject to change without notice in the interest of product improvement to the extent that product functions and applications will not be impaired.